



## County of San Mateo Planning & Building Department Agricultural Advisory Committee

BJ Burns  
Koren Widdel  
Jess Brown  
Jim Howard

John Vars  
Judith Humburg  
Laura Richstone  
Lauren Silberman

Louie Figone  
Frank McPherson  
Robert Marsh  
Ron Sturgeon

William Cook  
Cynthia Duenas  
Peter Marchi  
Natalie Sare

County Office Building  
455 County Center, 2<sup>nd</sup> Floor  
Redwood City, California 94063  
650/363-1829  
Fax: 650/363-4849

### *Revised Agenda* Special Meeting \*\*BY VIDEOCONFERENCE ONLY\*\*

**Date:** Monday October 19, 2020  
**Time:** 7:00 p.m. to 9:00 p.m.  
**Place:** Virtual Meeting due to COVID-19 Shelter in Place Order

Pursuant to the Shelter in Place Orders issued by the San Mateo County Health Officer and the Governor, the Governor's Executive Order N-29-20, and the CDC's social distancing guidelines which discourage large public gatherings, the Half Moon Bay Public Library is no longer open to the public for Agricultural Advisory Committee meetings.

#### **\* PUBLIC PARTICIPATION**

##### **Written Comments:**

Members of the public may provide written comments by email to [LRichstone@smcgov.org](mailto:LRichstone@smcgov.org) and should include the specific agenda item on which you are commenting, or note that your comment concerns an item that is not on the agenda.

The length of the emailed comment should be commensurate with the 5 minutes customarily allowed for verbal comments, which is approximately 300-400 words. To ensure your comment is received and read into the record for the appropriate agenda item, please submit your comments no later than 5:00 p.m. the day before the meeting. The County will make every effort to read emails received after that time, but cannot guarantee such emails will be read into the record. Any emails received after the deadline which are not read into the record will be provided to the Committee after the meeting and become part of the administrative record.

Individuals who require special assistance or a disability-related modification or accommodation to participate in this meeting, or who have a disability and wish to request an alternative format for the agenda, meeting notice, agenda packet, or other writings that may be distributed at the meeting should contact Laura Richstone, the Planning Liaison, by 10:00 a.m. on the Friday before the meeting at [LRichstone@smcgov.org](mailto:LRichstone@smcgov.org). Notification in advance of the meeting will enable the County to make reasonable arrangements to ensure accessibility to this meeting, the materials related to it, and your ability to comment.

##### **Virtual Meeting/Spoken Comments**

Spoke public comments will be accepted during the meeting through Zoom. **Please read the following instructions carefully:**

1. The October 19, 2020 Agricultural Advisory meeting may be accessed through Zoom online at the link <https://smcgov.zoom.us/j/98495142927>. The **meeting ID** is: **984 9514 2927**. The meeting may also be accessed via telephone by dialing +1 669-900-6833 (Local). Enter the meeting ID: 931 8347 8974, then press #. (To find your local number: <http://smcgov.zoom.us/u/admSDqceDg>).
2. You may download the Zoom client or connect to the meeting using an internet browser. If using your browser, make sure you are using a current, up to date browser: Chrome 30+, Firefox 27+, Microsoft Edge 12+, Safari 7+. Certain functionalities may be disabled in older browsers including internet explorer.
3. You may be asked to enter an email address and name. We request that you identify yourself by name as this will be visible online and will be used to notify you that it is your turn to speak.
4. When the Committee calls for the item on which you wish to speak, click on “raise hand” or \*9 if calling in on a phone. The Secretary will activate and unmute speakers in turn. Speakers will be notified shortly before they are called to speak.
5. When called, please limit your remarks to the time limit allotted.

**MATERIALS PERSENTED FOR THE MEETING:**

Applicants and members of the public are encouraged to submit materials to the Agricultural Advisory Committee. All materials (including but not limited to models and pictures) submitted on any item on the agenda are considered part of the administrative record for that item, and must be retained by the Committee Secretary. If you wish to retain the original of an item, a legible copy must be left with the Committee Secretary.

**AGENDAS AND STAFF REPORTS ONLINE:**

To view the agenda, please visit our website at <https://planning.smcgov.org/agricultural-advisory-committee>. Staff reports will be available on the website one week prior to the meeting. For further information on any item listed below please contact the corresponding Project Planner indicated.

**CORRESPONDENCE TO THE COMMITTEE:**

Laura Richstone, Agricultural Advisory Committee Liaison  
455 County Center, 2<sup>nd</sup> Floor  
Redwood City, CA 94062  
Email: [LRichstone@smcgov.org](mailto:LRichstone@smcgov.org)

**NEXT MEETING:**

The next regularly scheduled Agricultural Advisory Committee meeting will be held on November 9, 2020.

**AGENDA**  
**7:00 p.m.**

1. **Call to Order**
  2. **Member Roll Call**
  3. **Oral Communications** to allow the public to address the Committee on any matter not on the agenda. If your subject is not on the agenda, the Chair will recognize you at this time.
  4. **Committee Member Update(s) and/or Questions** to allow Committee Members to share news and/or concerns for items not on the agenda.
- 

**REGULAR AGENDA**

5. **General Plan Conformity Memo** clarifying when General Plan Conformities come before the AAC.
- 

6. **Owner:** Marsh Robert E & Julia M Trs  
**Applicant:** Midpeninsula Open Space District (MROSD)  
File Number: PLN 2020-00236  
Location: 1000 Verde Road Half Moon Bay  
Assessor's Parcel No. 066-280-050; 066-280-010; 066-010-020

Presentation by MROSD regarding a General Plan Conformity analysis for MROSD's proposal to purchase an undivided 54% interest in the 600-acre South Cowell Ranch property, and a subsequent land division resulting in a 371-acre Uplands property to be owned in fee by the District. This item was delayed due to the September 14, 2020 AAC meeting cancellation and was approved by the Planning Commission on September 23, 2020. Please direct any questions to Project Planner William Gibson at [WGibson@smcgov.org](mailto:WGibson@smcgov.org).

---

7. **Agritourism Motion Clarification Request** regarding a motion on the AAC's review of Agritourism Permits in an effort to streamline the process.

June 8, 2020 Motion:

*To streamline the agritourism permitting process, we recommend either allowing permits to last longer than one year or creating a simpler permit renewal process for agritourism permits with no change in activities from year to year.*

---

8. **Owner:** Dolores Togneri  
**Applicant:** David Repetto  
File Number: PLN 2020-00286  
Location: 12592 San Mateo Road, Half Moon Bay  
Assessor's Parcel No. 056-321-020

Consideration of an Agritourism Event Permit for the Repetto's 2020 October pumpkin selling season, October 1, 2020 – November 15, 2020. Proposed days and hours of operation are as follows: Daily from 9:00 a.m. to sunset. Proposed elements include a pumpking patch, hay ride, and corn maze; no operational changes from last season. Parking will occur in an existing open field on the 15-acre property. This item was delayed due to the September 14, 2020 AAC meeting cancellation. Please direct any questions to Project Planner Summer Burlison at [SBurlison@smcgov.org](mailto:SBurlison@smcgov.org).

---

9. **Owner/Applicant:** **Chris Gounalakis**  
File Number: PLN 2015-00084  
Location: 185 Verde Road, San Gregorio  
Assessor's Parcel No. 066-310-080

Consideration of a renewal of a Planned Agricultural District Permit and Coastal Development Permit to allow seasonal commercial recreation activities at the Arata Pumpking Farm; no operational changes are proposed. The project is appealable to the California Coastal Commission. This item was delayed due to the September 14, 2020 AAC meeting cancellation. Please direct any questions to Project Planner Summer Burlison at [SBurlison@smcgov.org](mailto:SBurlison@smcgov.org).

---

10. **Owner Applicant:** **Giusti Farms Joanne Giusti**  
File Number: PLN 2019-00488  
Location: 1800 Higgins Canyon Road,  
Assessor's Parcel No. 064-370-210

Consideration of a Coastal Development Permit and Planned Agricultural District Permit to allow four new farm labor housing units, a new septic system, a fire turnaround, and three new 5,000 gallon water tanks. Minimal grading and vegetation removal is proposed. No trees are proposed for removal. The project is appealable to the California Coastal Commission. Please direct any questions to Project Planner Olivia Boo at [OBoo@smcgov.org](mailto:OBoo@smcgov.org).

---

11. **Owner/Applicant:** **Janina Pawlowski**  
File Number: PLN 2017-00507  
Location: 4900 Cloverdale Road, Pescadero  
Assessor's Parcel No. 087-080-050

Consideration of an appeal of a County-initiated Non-Renewal of a Williamson Act Contract, that requires a determination of compatibility and exceptions to minimum eligibility requirements. The AAC must recommend to the Board of Supervisors either that the appealed parcel be allowed to remain contracted or that the non-renewal remains in effect allowing the contract to expire in 2026. Please direct any questions to Project Planner Kelsey Lang at [KLang@smcgov.org](mailto:KLang@smcgov.org).

---

12. **Committee Discussion and Update** on the CZU Complex Fire and current COVID-19 pandemic, potential policies needed to protect local agricultural and water from



contamination, how the pandemic may affect local food supply, and access to farm labor and resources available to producers and farm workers.

13. **Clarification Memo and Committee Discussion** regarding agritourism, permitted activities and educational events.
14. **Consideration of the Action Minutes** for the July 13, 2020 and August 10, 2020 regular meeting minutes will occur at the November 9, 2020 AAC Meeting.
15. **Community Development Director's Report**
16. **Adjournment**

---

Agricultural Advisory Committee meetings are accessible to people with disabilities. Individuals who need special assistance or a disability-related modification or accommodation (including auxiliary aids or services) to participate in this meeting; or who have a disability and wish to request an alternative format for the agenda, meeting notice, agenda packet or other writings that may be distributed at the meeting, should contact the County Representative at least five (5) working days before the meeting at (650) 363-1829, or by fax at (650) 363-4849, or e-mail LRichstone@smcgov.org. Notification in advance of the meeting will enable the Committee to make reasonable arrangements to ensure accessibility to this meeting and the materials related to it.

**ROLL SHEET – October 2020**

Agricultural Advisory Committee Attendance 2019-2020

	Oct	Nov	Dec	Jan	Feb	Mar	Apr	May	May*	Jun	Jul	Aug	Sept	Oct
<b>VOTING MEMBERS</b>														
Judith Humburg** Public Member		X		X		X	X	X	X	X	X	X		
BJ Burns Farmer, Vice Chair		X		X		X	X	X	X	X	X	X		
Natalie Sare* Farmer		X	X	X	X	X	X		X	X	X	X		
Louie Figone Farmer		X	X		X	X		X	X					
Cynthia Duenas** Public Member		X	X		X	X	X	X		X	X	X		
John Vars Farmer				X	X	X	X	X	X	X	X	X		
William Cook Farmer		X	X	X			X	X	X	X	X	X		
Peter Marchi** Farmer		X	X	X	X	X	X	X		X				
Robert Marsh Farmer, Chair		X	X	X	X	X			X					
Ron Sturgeon Conservationist		X		X	X	X	X	X		X	X	X		
Lauren Silberman Ag Business		X	X	X	X	X	X	X	X	X	X	X		
Natural Resource Conservation Staff Jim Howard														
San Mateo County Agricultural Commissioner Koren Widdel		X	X	X		X		X	X	X	X	X		
Farm Bureau Executive Director Jess Brown			X		X	X	X	X	X	X	X	X		
San Mateo County Planning Staff Laura Richstone							X	X	X	X	X	X		
UC Co-Op Extension Representative Frank McPherson				X			X	X	X					

**X: Present**

**Blank Space: Absent or Excused**

**Grey Color: No Meeting**

**\* Special Meeting**

**\*\* As of 06/25/2019**



**COUNTY OF SAN MATEO - PLANNING AND BUILDING DEPARTMENT**

**ITEM**

**5**

# MEMORANDUM

## COUNTY OF SAN MATEO PLANNING AND BUILDING DEPARTMENT

**DATE:** October 19, 2020  
**TO:** Agricultural Advisory Committee  
**FROM:** Laura Richstone, Planning Department Liaison  
**SUBJECT:** Clarification on AAC Review of General Plan Conformity Applications

---

California Government Code Section 65402 requires that prior to a local public agency's purchase of a property, the agency must request an analysis of the proposed acquisition's conformity with the County's General Plan. The authority of assessing a General Plan Conformity (GPC) has been delegated to the Planning Commission by the Board of Supervisors. In this analysis local agencies are not required to provide the County with specific development plans or details in their submittal.

Most GPCs in the PAD are typically submitted by the Midpeninsula Regional Open Space District (MROSD), a public agency. The Peninsula Open Space Trust (POST) is another large rural landowner however they are a non-profit entity and not required to go through the GPC process. In MROSD's case, they generally provide details of the purchase and the intended use of the property as open space, low intensity recreational use, among others including conservation, and often commit to maintaining the property as is (including agricultural uses) until additional planning is complete. In effect, GPCs assess the purchase of a property and the conformity of the public agency's broader general mission with the General Plan.

GPCs are based only on the policies of the General Plan itself, do not assess any specific proposed development, and do not involve the PAD zoning regulations. Any future development on PAD zoned lands would be assessed subsequently, required to obtain the necessary Planning permits, and be reviewed by the AAC.

Though the AAC will see future proposed development which requires a PAD permit, there is no information by which to assess proposed development (nor findings to be made by the AAC) at the property transfer, or GPC, stage. As such, GPCs are typically not seen before the AAC unless the applicant requests such review.

It should also be noted that the Government Code does not bind the local agency to the findings of the GPC but only requires that the local agency requests the analysis be conducted. Though typically not seen by the AAC, GPCs located in the PAD will be noted in the Director's Report and Members of the AAC always have the opportunity to comment on GPCs before the Planning Commission.



**COUNTY OF SAN MATEO - PLANNING AND BUILDING DEPARTMENT**

**ITEM**

**8**

**COUNTY OF SAN MATEO  
PLANNING AND BUILDING DEPARTMENT**

**DATE:** October 19, 2020

**TO:** Agricultural Advisory Committee

**FROM:** Summer Burlison, Planning Staff, 650/363-1815

**SUBJECT:** Consideration of an Agritourism Event starting on October 1, 2020 and ending on November 15, 2020, located at 12592 San Mateo Road in unincorporated Half Moon Bay (Repetto's Pumpkins).

County File Number: PLN 2020-00286 (Repetto/Togneri)

**PROPOSAL**

The applicant, Repetto, has applied for an Agritourism Event for the upcoming 2020 October pumpkin selling season, October 1, 2020 – November 15, 2020, at 12592 San Mateo Road, unincorporated Half Moon Bay (Repetto's Pumpkins). The proposed days and hours of operation are as follows: Daily from 9:00 a.m. to sunset. The proposed Event elements include a pumpkin patch, hay ride, and corn maze. Parking for the Event will occur in an existing open field on the 15-acre property. There will be 4-6 employees on the site. No changes are proposed from the previous year's Event operation.

This item was originally scheduled for the September 14, 2020 Agricultural Advisory Committee meeting; however, that meeting was cancelled.

**DECISION MAKER**

Community Development Director

**QUESTIONS FOR THE AGRICULTURAL ADVISORY COMMITTEE**

1. Is the agritourism use compatible with the long-term agricultural uses of the land?
2. Will the agritourism operation have any adverse effect on surrounding agricultural uses? If so, can any conditions of approval be recommended to minimize any such impact?
2. What decision do you recommend the Community Development Director take with respect to this application?

## **BACKGROUND**

Report Prepared By: Summer Burlison, Project Planner

Applicant: David Repetto

Owner: Dolores Togneri c/o Lagomarsino Properties

Location: 12592 San Mateo Road, unincorporated Half Moon Bay

APN: 056-321-020

Parcel Size: 15 acres

Existing Zoning: Planned Agricultural District/Coastal Development (PAD/CD)

General Plan Designation: Agriculture

Local Coastal Plan Designation: Agriculture

Williamson Act: The subject parcel is not encumbered by a Williamson Act contract.

Existing Land Use: Agriculture including ornamental flowers, pumpkins and corn

Water Supply: Private agricultural well permitted in 1991 (CDX91-0080) and an agricultural water impoundment permitted in 1991 (GRX91-00004).

Sewage Disposal: None.

Flood Zone: Flood Zone A (1% annual chance of flooding) and Flood Zone X (area of minimal flooding), pursuant to Federal Emergency Management Agency, Flood Insurance Rate Map, Community Panel 06081C0260E, effective October 16, 2012.

Environmental Evaluation: Categorically exempt from environmental review pursuant to Section 15304, Class 4, of the California Environmental Quality Act (CEQA) Guidelines, for the minor temporary use of land having negligible or no permanent effects on the environment.

Setting: The subject 15-acre parcel is located on the south side of San Mateo Road, also known as California Highway 92, and is visible from the roadway. The site is relatively flat and just slightly lower in elevation from the roadway.



Chronology:

<u>Date</u>	<u>Action</u>
October 2019	- Agritourism Event permit, PLN2019-00407, approved.
August 2020	- Subject Agritourism Event application submitted, PLN2020-00286.
September 14, 2020	- Agricultural Advisory Committee public meeting; meeting cancelled and item rescheduled.
October 19, 2020	- Agricultural Advisory Committee public meeting.

*Will the project be visible from a public road?*

Yes, the project site is visible from San Mateo Road/Highway 92; however, the Event is secondary, and supplemental to ongoing agricultural use of the land, and as a seasonal event not uncharacteristic for the area.

*Will any habitat or vegetation need to be removed for the project?*

No.

*Is there prime soil on the project site?*

Yes, a majority of the parcel contains prime soils as illustrated in Attachment B.

## **DISCUSSION**

### A. **KEY ISSUES**

Planning staff has reviewed this application for conformance with the following Agritourism Guidelines and Performance Standards:

1. **Temporary Seasonal Agritourism Uses and Activities**
  - a. The Agritourism operation will not interfere with agricultural production on or adjacent to the lot.

The Agritourism Event does not interfere with the agricultural use of the land, which includes the growing of ornamental flowers, pumpkins, and corn.

- b. The Agritourism event will not exceed a maximum of 45 consecutive days and will not occur more than two times per year.

The proposed Agritourism Event is for the October 1, 2020 – November 15, 2020 (typical) pumpkin season.

- c. The Agritourism event will operate within the guideline’s allowance of Sunday through Saturday from 9:00 a.m. to sunset; no lighting is allowed.

The Event will operate daily from 9:00 a.m. to sunset. No lighting is proposed in association with the Event; therefore, the proposal meets these requirements.

- d. The Agritourism event will consist of no more than the maximum allowed uses and activities indicated below:

<b>Maximum Allowed Agritourism Use/Activity</b>	<b>Proposed (Quantity)</b>
Two (2) inflatables <sup>1</sup> allowed on all lands <sup>2</sup>	
One (1) pony ride area <sup>3</sup>	
One (1) farm animal petting zoo on all lands	
One (1) hayride on all lands	1
One (1) train with rubberized wheels on all lands	
One (1) food vendor, mobile or on-site, including mobile prepackaged food/snack bar <sup>4</sup> , located on all soils	
One (1) prepackaged food/snack bar on non-prime soils <sup>4</sup>	
Other recreational/educational activities, see discussion below	1
<sup>1</sup> Inflatables are subject to the standards of the Safe Inflatable Operators Training Organization. <sup>2</sup> Subject to a 36-foot height limit as set forth in the Planned Agricultural District and Resource Management District Regulations. <sup>3</sup> Confined animal permit or exemption required. <sup>4</sup> Environmental Health Permit required.	

*Other recreational/educational activities:*

In addition to operating a pumpkin patch and hayrides, the Event will include a corn maze.

2. Performance Standards for Seasonal Agritourism Uses and Activities

- a. Adequate on-site parking is provided including conformance with applicable provisions from Local Coastal Program Policy 10.22 (*Parking*) for adequate parking facilities to accommodate the temporary seasonal uses that are appropriate for the site's size, environmental sensitivity, and amount of land suitable for parking; and that are not visually prominent from public views.

Approximately 1 acre of the property will be designated for parking in association with the Event. The area for parking is a large open field in the western portion of the property, nearest the roadway; this area has been used in past years for parking during the annual pumpkin season Event at the property. While this parking area is visible from San Mateo Road/Highway 92, there will be no modifications made to the area to accommodate parking so that the designated area maintains a natural and rural setting complementary to the surrounding area.

- b. Any new signage will be temporarily established and maintained throughout the duration of the Agritourism event, as allowed pursuant to Local Coastal Program Policy 8.21 (*Commercial Signs*), will be simple and easy to read, and will not be brightly illuminated colored, rotating, reflective, blinking, flashing or moving signs, pennants, or streamers.

Temporary signage meeting these requirements, as provided in past years, will be erected for the seasonal operation.

- c. All Agritourism uses and activities shall meet the current standards for setbacks and buffers from watercourses, including creeks, and/or riparian vegetation.

All uses and activities associated with the Agritourism Event will be located on the front half of the lot, farthest away from nearby Pilarcitos creek and its natural habitat.

- d. On parcels under forty (40) acres in size, all agritourism elements shall be clustered and shall consume no more than one (1) gross acres (excluding hayrides or trains with rubberized wheels); parking is excluded from this acreage calculation.

The proposal meets these requirements.

- e. The agritourism operation shall not involve any land disturbance, including import of gravel or fill.

No land disturbance is necessary to accommodate the Event.

3. Recommended Findings for the Agritourism Event

- a. That the agritourism use is compatible with the long-term agricultural uses of the land as the proceeds from the Agritourism Event, including pumpkin sales, supports the economic viability of the farm and does not prevent future agricultural uses on the land.
- b. That the agritourism operation will not adversely affect the health or safety of persons in the area and will not be materially detrimental to the public welfare or injurious to agricultural property. Staff has evaluated the Event proposal and finds there will be no negative impacts on the agricultural uses of the land. Staff believes that use of the land for the proposed seasonal Event is of a greater benefit than letting the land lay fallow. Further, the applicant is responsible for following all restrictions set forth through State and County Health Orders related to COVID-19, including but not limited to social distancing protocols and health and safety plan requirements applicable to the Event.
- c. That the agritourism operation is in substantial conformance with the goals set forth in the San Mateo County Agritourism Guidelines. Specifically, that the operation is secondary and supplemental to existing agricultural operation on the land.
- d. That the proposed use and activities comply with all relevant provisions of the General Plan, Local Coastal Program, and Zoning Regulations as discussed throughout this report.

**ATTACHMENTS**

- A. Vicinity Map
- B. Prime Soils Map
- C. Site Plan

\_ACC Agritainment Event SR (5-27-20).dotx



COUNTY OF SAN MATEO - PLANNING AND BUILDING DEPARTMENT

# ATTACHMENT A



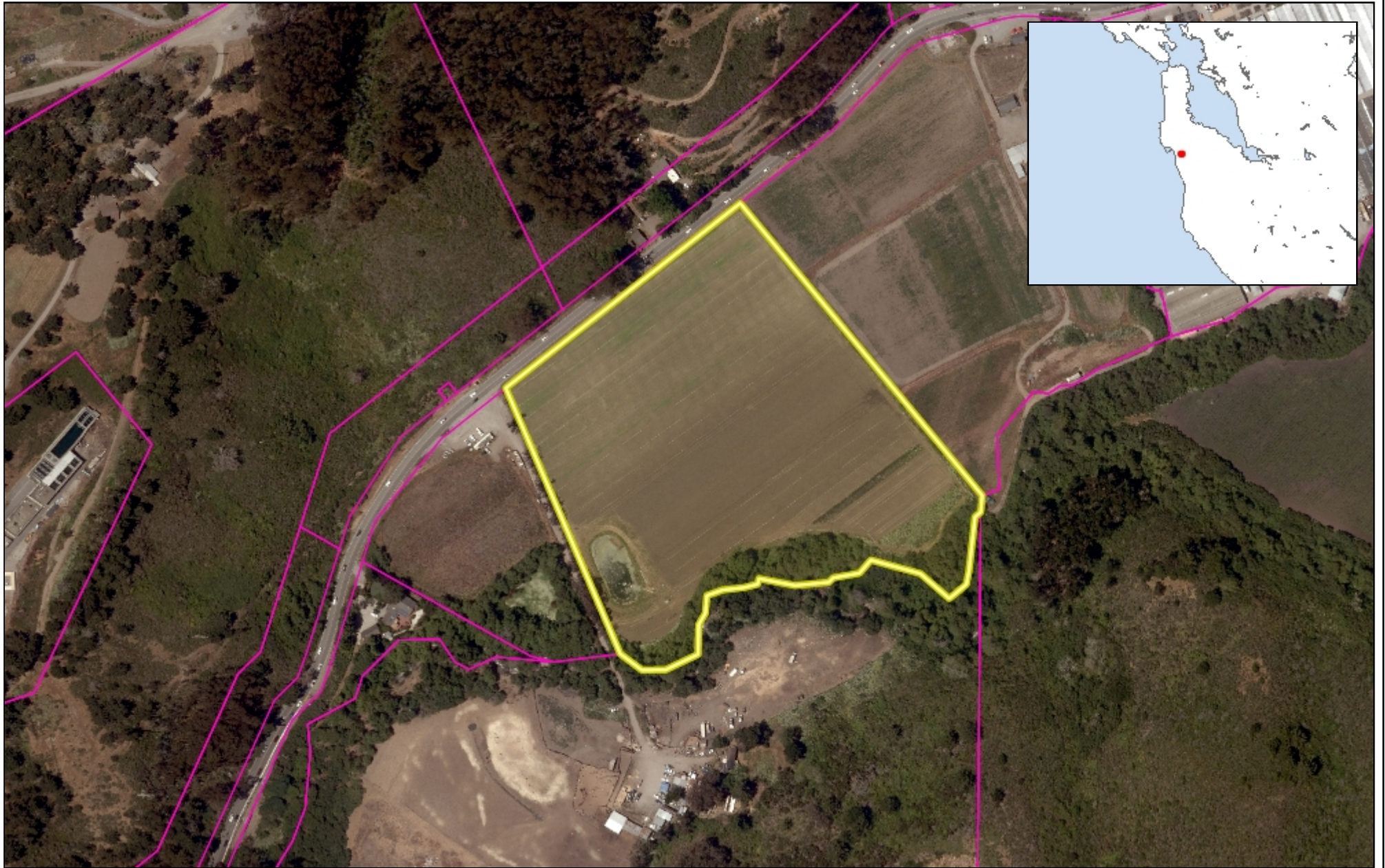

0.14 0 0.07 0.14 Miles

WGS\_1984\_Web\_Mercator\_Auxiliary\_Sphere  
© Latitude Geographics Group Ltd.

1:4,514



This map is a user generated static output from an Internet mapping site and is for reference only. Data layers that appear on this map may or may not be accurate, current, or otherwise reliable.

**THIS MAP IS NOT TO BE USED FOR NAVIGATION**



COUNTY OF SAN MATEO - PLANNING AND BUILDING DEPARTMENT

# ATTACHMENT B



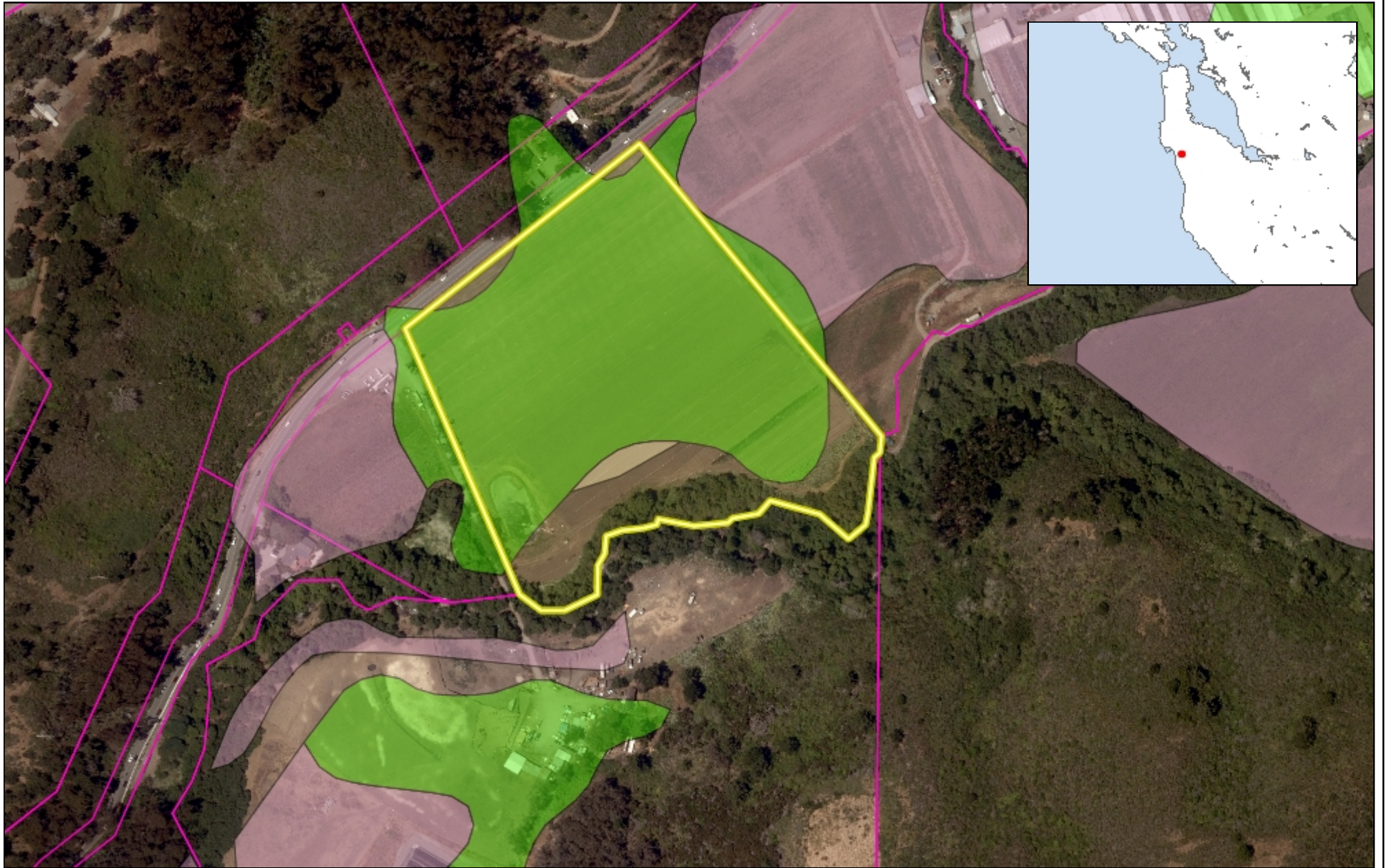

0.14 0 0.07 0.14 Miles

WGS\_1984\_Web\_Mercator\_Auxiliary\_Sphere  
© Latitude Geographics Group Ltd.

1:4,514 

This map is a user generated static output from an Internet mapping site and is for reference only. Data layers that appear on this map may or may not be accurate, current, or otherwise reliable.

**THIS MAP IS NOT TO BE USED FOR NAVIGATION**



COUNTY OF SAN MATEO - PLANNING AND BUILDING DEPARTMENT

# ATTACHMENT C

Hwy 92

Pumpkin Patch

Pumpkin Patch

Parking

Entrance

Entrance

Hay Ride

Corn Maze

Cut Flowers

Cut Flowers

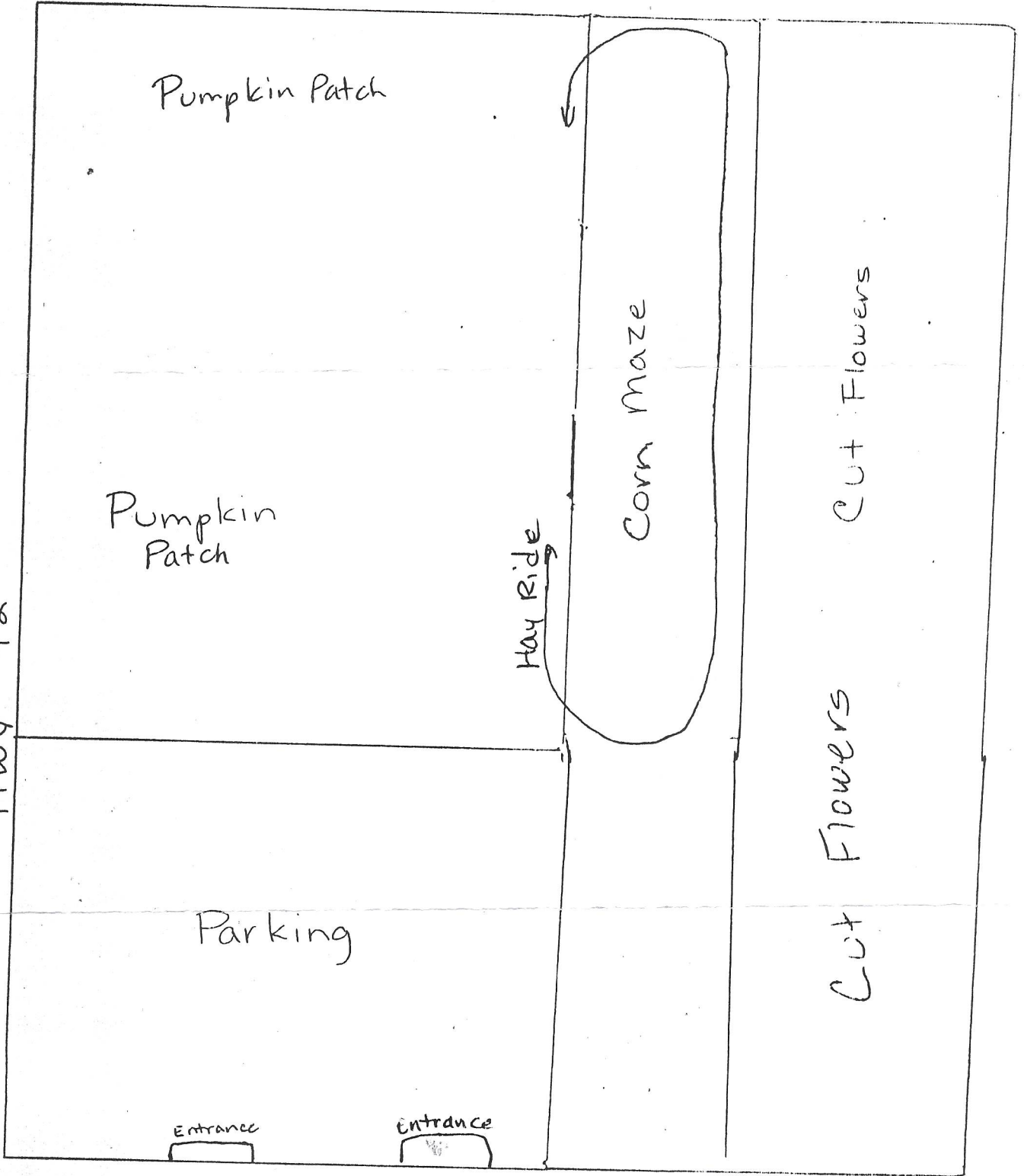



**COUNTY OF SAN MATEO - PLANNING AND BUILDING DEPARTMENT**

**ITEM**

**9**

**COUNTY OF SAN MATEO  
PLANNING AND BUILDING DEPARTMENT**

**DATE:** October 19, 2020

**TO:** Agricultural Advisory Committee

**FROM:** Summer Burlison, Planning Staff, 650/363-1815

**SUBJECT:** Consideration of a renewal of a Planned Agricultural District Permit, pursuant to Section 6350 of the San Mateo County Zoning Regulations, and a Coastal Development Permit, pursuant to Section 6328.4 of the San Mateo County Zoning Regulations, to allow continued seasonal commercial recreation activities at the Arata Pumpkin Farm located at 185 Verde Road in the unincorporated San Gregorio area of San Mateo County.

County File Number: PLN 2015-00084 (Gounalakis)

**PROPOSAL**

(This item was originally scheduled for the September 14, 2020 Agricultural Advisory Committee meeting; however, that meeting was cancelled)

The applicant proposes to renew the Planned Agricultural District Permit and Coastal Development Permit to continue seasonal commercial recreation activities for the 2020 – 2025 fall/winter season (5-year permit). The seasonal commercial recreation activities at the Arata Farm property are proposed to take place between August 1 and November 1 for five years, with no use or activity changes from the previous 2017 approved Planning Agricultural District Permit and Coastal Development Permit. Continued commercial recreation activities would be limited to a hay maze, a haunted barn, a play set/jumper, a petting zoo, pony rides, train rides, a snack bar, food truck, and associated parking spaces.

During the seasonal recreation period, approximately 62% of the property remains in permanent agriculture. During the remaining nine (9) months of the year, the entire property (with the exception of the developed area and the play set/jumper area) is used for agricultural production, with seedling/starter plants (non-soil dependent) and agricultural storage in areas used for parking and crop production in all other areas. Crops to be grown are fava beans, pumpkins, corn, bell beans, and Stone Pine Christmas trees. As shown in Table 2, crops are to be grown in six zones, Zone A through F, on the property.



Table 2 Crop Production By Zone, see Attachment C for Zones						
	A	B	C	D	E	F
November	Christmas Trees	Fallow/Cover Crop				
December						
January						
February						
March						
April		Peas*/ Stone Pines*/ Fava Beans/ Christmas Trees	Fava Beans	Corn/ Pumpkins	Stone Pines	Seedlings/ Starter Plants
May						
June						
July						
August						
September		Harvest/Sales				None (Parking)
October						
*Entire zone planted, excluding areas of the hay maze and parking for month of August.						

Previously (2017) permitted hours of operation: July 1 – November 1 (except October)

Monday – Friday: 9:00 a.m. – 6:00 p.m.

Saturday: 9:00 a.m. – 9:00 p.m.

Sunday: 9:00 a.m. – 8:00 p.m.

No changes are proposed under the subject renewal.

Previously (2017) permitted hours of operation: October

Monday – Thursday: 9:00 a.m. – 7:00 p.m.

Friday and Saturday: 9:00 a.m. – 10:00 p.m.

Sunday: 9:00 a.m. – 7:00 p.m.

No changes are proposed under the subject renewal.

### **DECISION MAKER**

Zoning Hearing Officer

### **QUESTIONS FOR THE AGRICULTURAL ADVISORY COMMITTEE**

Regarding the Planned Agricultural District Permit and Coastal Development Permit:

1. Will the proposal have any negative effect on surrounding agricultural uses? If so, can any conditions of approval be recommended to minimize any such impact?
2. What position do you recommend that the Planning Department staff take with respect to the application for this project?

## **BACKGROUND**

Report Prepared By: Summer Burlison, Project Planner

Owner/Applicant: Chris Gounalakis

Location: 185 Verde Road, San Gregorio

APN: 066-310-080

Size: 8.37 acres

Existing Zoning: Planned Agricultural District/Coastal Development (PAD/CD)

General Plan Designation: Agriculture

Local Coastal Program Designation: Agriculture

Williamson Act: Contracted in 1967 (AP67-39) and amended in September 2012

Existing Land Use: Agricultural uses, residence, barns, accessory buildings, and seasonal recreation activities

Flood Zone: Zone X (area of minimal flooding); FEMA FIRM Panel 06081C0269F; effective October 2, 2017

Setting: The project parcel is located on Verde Road to the east of Cabrillo Highway, is developed and is relatively flat in terrain. Lobitos Creek runs along the northern perimeter of the parcel. The parcel contains a 0.88-acre developed area containing paved driveways and five (5) legal structures: a 1,500 sq. ft. single-family residence, three barns (1,800 sq. ft., 500 sq. ft. and 300 sq. ft.), and a 900 sq. ft. store building. The buildings were constructed in the 1930s, prior to building permit requirements.

Environmental Evaluation: Categorically exempt from further environmental review pursuant to Section 15301, Class 1, of the California Environmental Quality Act (CEQA) Guidelines for the continued operation of an approved facility/activities with no changes or expansion of uses.

Chronology:

<u>Date</u>	<u>Action</u>
1967	- Property owner enters into Williamson Act contract (AP67-39) with San Mateo County.



- 1999 - Applicant (Mr. Gounalakis) leases property from the Arata family.
- 2005 - Agricultural operation is expanded without the benefit of permits to include seasonal commercial recreation activities during the months of May through October.
- 2009 - Complaint filed to the County regarding the expansion of unpermitted activities. Applicant is directed by the County to cease all unpermitted activities on the property until the required permits were secured.
- Fall/Winter 2010 - Applicant conducts seasonal recreation activities under "Interim Operating Conditions" issued by the County for 2010 only.
- Fall/Winter 2011 - Board of Supervisors approves seasonal recreation uses at the property for 2011 only (PLN 2010-00207). Project is appealed to the Coastal Commission; no action is taken by the Coastal Commission
- September 25, 2012 - Board of Supervisors amends the Williamson Act contract for the property to allow commercial recreation uses (PLN 2012-00178).
- Fall/Winter 2013 - No hay maze is constructed.
- May 12, 2014 - Agricultural Advisory Committee meeting to review proposed activities for 2014.
- June 25, 2014 - Planning Commission approves seasonal recreation uses at the property for 2014 only (PLN 2013-00494). Project is appealed to the Coastal Commission; no action is taken by the Coastal Commission.
- May 11, 2015 - Agricultural Advisory Committee meeting to review proposed activities for 2015 (PLN2015-00084). Item continued to June 8, 2015.
- June 8, 2015 - AAC reviewed the item and made no recommendation on the development project. The requested minimum parcel size exception was heard by the Agricultural Advisory Committee and received one recommendation of denial by the AAC and one recommendation of approval by the Agricultural Commissioner.

- July 22, 2015 - Planning Commission approved seasonal recreation uses at the property for 2015 and 2016 with option to renew the permit.
- December 22, 2016 - Application submitted to San Mateo County Planning for renewal of permits.
- April 10, 2017 - AAC reviewed the item and recommended approval of a 1-year permit for the project. The AAC also recommended that the Planning Commission not grant the proposed extended hours, instead leaving in place the hours of operation that were approved in 2015.
- May 10, 2017 - Planning Commission approved a 3-year permit for seasonal recreation uses at the property with no extended hours, instead leaving in place the hours of operation that were approved in 2015.
- August 2017 - Planning staff completed annual administrative review and inspection per permit condition of approval.
- August 2018 - Planning staff completed annual administrative review and inspection per permit condition of approval.
- August 2019 - Planning staff completed annual administrative review and inspection per permit condition of approval.
- February 5, 2020 - Application submitted to San Mateo County Planning for renewal of permits for seasonal recreational uses at the property; no changes from last approval proposed; however, the applicant requests a 5-year permit.
- September 14, 2020 - AAC public meeting; meeting cancelled and item rescheduled.
- October 19, 2020 - AAC public meeting.

*Will the project be visible from a public road?*

The western edge of the property runs along Cabrillo Highway, a portion that is designated as a State scenic corridor. As proposed, the western portion of the property would remain in agricultural production (i.e., corn and pumpkin fields). The “castle,” metal gorilla, and “arena” seen in the past will not be installed on the property as part of this project.

The temporary hay maze structure and other commercial recreation uses are located on the eastern half of the property and would be somewhat visible from Cabrillo Highway. The applicant proposes to construct a main portion of the maze in areas of non-prime

soil south of Lobitos Creek and immediately adjacent to developed areas of the property (see Map of Prime Soil and Seasonal Commercial Recreation Activities included as Attachment C). In this location, the hay maze would cover a smaller area of prime soils and would be located further and be less visible from Cabrillo Highway. Also, the pony ride will continue to be located in the developed areas of the property. In the past, the applicant had constructed a “castle” and “arena” and located a train ride on prime soils. These elements continue to not be included in this proposal.

*Will any habitat or vegetation need to be removed for the project?*

The hay maze will continue to be located temporarily in areas used for agriculture and will not result in the removal of vegetation. The proposed parking area is not located on prime soils and will not result in the removal of vegetation. The starter plants that are located in the parking area are not soil-dependent, instead they are container-based.

*Is there prime soil on the project site?*

As shown in Attachment B, a majority of the site is characterized by prime soils, consisting of Class II (TuB – Tunitas clay loam, gently sloping) and Class IV Cld2 (Sandy Loam, moderately steep). Areas of prime soils are largely occupied by agricultural uses, with the exception of developed areas and a small portion that will be occupied by parking and a section of the hay maze during the recreational season.

Remaining areas consist of Class VII (Ma – Mixed alluvial), areas considered “lands suitable for agriculture.” These areas are largely occupied by agricultural uses (mostly container-based, non-soil dependent agriculture), with the exception of developed areas and areas occupied by parking and the hay maze during the recreational season.

## **KEY ISSUES**

Planning staff has reviewed this proposal and presents the following key issues for the Agricultural Advisory Committee’s consideration:

### 1. Compliance with Planned Agricultural District (PAD) Regulations

In order to approve and issue a PAD Permit renewal, the project must comply with the substantive criteria for the issuance of a PAD Permit, as applicable and as delineated in Section 6355 of the Zoning Regulations. As proposed and to be conditioned, the proposal complies with the following applicable policies. Further discussion can be found under Compliance with Local Coastal Program Agriculture Component Policies in Section 2, below.

- a) The encroachment of all development upon land which is suitable for agricultural uses and other lands shall be minimized.
- b) All development permitted on a site shall be clustered.

- c) Development shall be located, sited and designed to carefully fit its environment so that its presence is subordinate to the pre-existing character of the site and its surrounding is maintained to the maximum extent practicable.
- d) Small, separate parking areas are preferred to single large parking lots.
- e) No use, development or alteration shall substantially detract from the scenic and visual quality of the County; or substantially detract from the natural characteristics of existing major watercourses, established and mature trees and other woody vegetation, dominant vegetative communities or primary wildlife habitats.
- f) No off-premises outdoor advertising shall be permitted. Other permitted signs shall be carefully designed to harmonize with the scenic qualities of scenic corridors.
- g) Where possible, structural uses shall be located away from prime agricultural soils.

2. Compliance with Agriculture Component Policies of the Local Coastal Program (LCP)

*Prime Agricultural Lands*

LCP Policy 5.5 (*Permitted Uses on Prime Agricultural Lands*) permits agricultural and agriculturally related development on prime agricultural lands; non-residential development customarily considered accessory to agricultural uses including barns, storage/equipment sheds, stables for farm animals, water wells, and water storage tanks; and temporary road stands for seasonal sale of produce grown in San Mateo County, among other uses.

For areas of prime soils, the continued operation involves the following: (1) the use of the existing barn and the location of the petting zoo, the pony ride, food truck, snack stand, and train ride are within the developed area for commercial recreation use, (2) the temporary construction of a portion of the hay maze, and (3) location of temporary parking adjoining developed areas of the property. The following is a discussion of each project component and policy compliance:

- a) Use of Barn and the Location of Petting Zoo, Pony Ride and Train Ride within Developed Area for Commercial Recreation Use: These uses within the existing developed areas of prime soils are consistent with Policy 5.5 since the proposal clusters development in an area where existing development prevents the use of prime soil for agricultural production.

- b) Temporary Construction of a Portion of the Hay Maze: The area of prime soil that is occupied temporarily by a portion of the hay maze (approximately 5,600 sq. ft.) has been used as an entrance to the property since at least 2005. The continued use significantly reduces the acreage of prime soil used for the hay maze by approximately 35% over the 2011 hay maze location. The hay maze is a temporary structure used from July 1 to November 1 and would not deplete the productivity of the soil. At the end of the Halloween/Pumpkin Season on November 1, operation of the hay maze ends. Within 30 days, the applicant will be required to deconstruct the hay maze. In the past, the applicant has stacked the hay in clusters not on prime soils and in areas minimally visible from Highway 1.
  
- c) Location of Temporary Parking Adjoining the Developed Area: Temporary parking to support commercial recreation use would be located in areas used in the past for parking. These areas directly adjoin developed areas and are located at the entrance of the property. While leaks from automobiles likely have depleted the productivity of the soil, the applicant continues to use the area for container-based, non-soil dependent agricultural uses.

#### *Lands Suitable for Agriculture*

LCP Policy 5.6 (*Permitted Uses on Lands Suitable for Agriculture Designated as Agriculture*) permits agricultural and agriculturally related development on lands suitable for agriculture, including agriculture and non-soil dependent agricultural uses such as greenhouses and nurseries. The policy also conditionally permits commercial recreation including country inns, stables, riding academies, campgrounds, rod and gun clubs, and private beaches. In these areas, the continued operation involves the following: (1) maintenance of a play set; (2) construction of a hay maze; and (3) location of temporary parking to support commercial recreation uses. These commercial recreation uses are permitted with the approval of a Planned Agricultural District (PAD) Permit.

### 3. Compliance with the Williamson Act

The property has been in a Williamson Act contract (AP67-39) since 1967. The contract was amended in September 2012 (PLN 2012-00178) to allow for the proposed commercial recreation uses and reads as such”

*During the term of this Agreement [Williamson Act Contract] the above described land shall not be used for any purpose, other than the production of agricultural commodities for commercial purposes and certain compatible uses of the underlying land use designation and zoning of the parcel and subject to applicable permits, as follows: structures that are directly related to and compatible with agricultural use; residence buildings for such individuals as may be engaged in the management of said land, and their families; and agriculturally related*

seasonal visitor-serving uses such as pony rides, hay rides, a farm animal petting zoo, a children’s play area (including up to two inflatable play structures), a seasonally decorated barn, a farm-themed children’s train ride, and a hay bale maze, provided, however, that for all such seasonal visitor-serving uses the Owner will secure, at Owner’s expense, private or public agency traffic safety services satisfactory to the Community Development Director, and further provided that no food shall be prepared on site for sale to visitors. Regardless of the applicability of permit requirements, any seasonal installation of compatible use structures and other materials on the parcel is subject to the timely approval by the Community Development Director of a site plan to ensure that annual agricultural productivity of the parcel is not substantially affected by seasonal activities. Nothing in this Agreement shall prohibit the use of the property as a farm education center pursuant to necessary permits issued by the County so long as the farm continues to be dedicated to the production of agricultural commodities for commercial purposes.

The uses proposed are compliant with the compatible uses outlined in the Williamson Act contract.

*Williamson Act Program Eligibility Requirements*

Review of minimum eligibility requirements include Assessor’s Office Agricultural Preserve Questionnaires and documents submitted by the owner. Crop income is held confidential; review of this criterion is identified only as “Completed.”

<b>APN 066-310-080</b>	<b>Williamson Act Program Requirements</b>	<b>Planning Review</b>	<b>Compliance</b>
Land Use Designation	Open Space or Agriculture	Agriculture	Yes
Zoning <sup>1</sup>	PAD, RM, or RM-CZ	PAD	Yes
Parcel Size <sup>2</sup>	40 Acres	8.37 Acres	No
Prime Soils <sup>3</sup>	--	3.95 Acres	--
Non-Prime Soils	--	4.42 Acres	--
Crop Income <sup>4,6</sup>	\$10,000	Completed	Yes
Grazing Utilization <sup>5,6</sup>	40 Acres	--	--
Horse Breeding	15 Broodmares	--	--
<ol style="list-style-type: none"> <li>1. Zoning designations: “PAD” (Planned Agricultural District), “RM” (Resource Management), and “RM-CZ” (Resource Management-Coastal Zone).</li> <li>2. Parcel size taken from the San Mateo County Assessor’s Office records.</li> <li>3. Prime soils: Class I or Class II (U.S. Department of Agriculture Soil Conservation Service Land Use Capability Classification), Class III lands capable of growing artichokes or Brussels sprouts, and lands qualifying for an 80-100 Storie Index Rating taken from the Planning and Building Department GIS data.</li> <li>4. Required income calculated per Income Requirements for Crops (Uniform Rule 2.A.6).</li> <li>5. Grazing land utilization is 75% of parcel acreage (Uniform Rule 2.A.7).</li> <li>6. Crop income and grazing data taken from Assessor’s Office Agricultural Preserve Questionnaire response using the highest income and grazing acreage of the previous three years for purposes of this review. Contracted parcels are required to meet the minimum commercial crop income, commercial grazing land utilization, or commercial horse breeding.</li> </ol>			

### Agricultural Uses

Commercial agriculture includes 3.77 acres for permanent agriculture. Peas, fava beans, corn, stone pines, pumpkins, and seedlings are grown on the property.

### Existing Development

The property is developed with a single-family house, one barn, a snack bar, a play set, one office trailer, and two sheds. The applicant constructs a temporary hay maze and parking area for seasonal recreational use.

### Determination of Compatibility

The landowner has submitted the requested supplemental documentation in order to calculate the compatible and agricultural uses required by the Williamson Act Program (Program).

*The percentage of a parcel's total area used for compatible uses on contracted lands cannot exceed the percentage used for agricultural uses and the portion of the parcel used for compatible uses cannot exceed 25% of the parcel size.*

Building and structures used to support the agricultural use, unpaved roads, farm labor housing, and underground utilities are excluded from this calculation.

### *Maximum Allowance of Compatible Uses Calculation*

#### 8.37-Acre Parcel:

Agricultural uses: 5.23 acres (62% of parcel) of peas, stone pine trees, fava beans, corn, pumpkins, and seedlings.

Compatible uses: 1.32 acres (16% of parcel) of developed area, parking, hay maze and play set/jumper.

These uses have been determined compatible as amended by the Board in 2012.

### Staff Evaluation

Based on the information submitted by the landowner, the property complies with the Williamson Act requirements for crop income and compatibility of uses. In 2015, an exception to the minimum parcel size was reviewed and granted. No changes to the size of the parcel are proposed. The contracted area is otherwise in compliance with the minimum eligibility requirements.



## **ATTACHMENTS**

- A. Vicinity Map
- B. Prime Soils Map
- C. Agricultural Activities Site Plan 2020
- D. Seasonal Commercial Recreation Activities Site Plan 2020
- E. Previously Approved Agricultural Activities Site Plan 2017
- F. Previously Approved Seasonal Commercial Recreation Activities Site Plan 2017
- G. Previously Approved 2017 PAD and CDP conditions of approval



COUNTY OF SAN MATEO - PLANNING AND BUILDING DEPARTMENT

# ATTACHMENT A

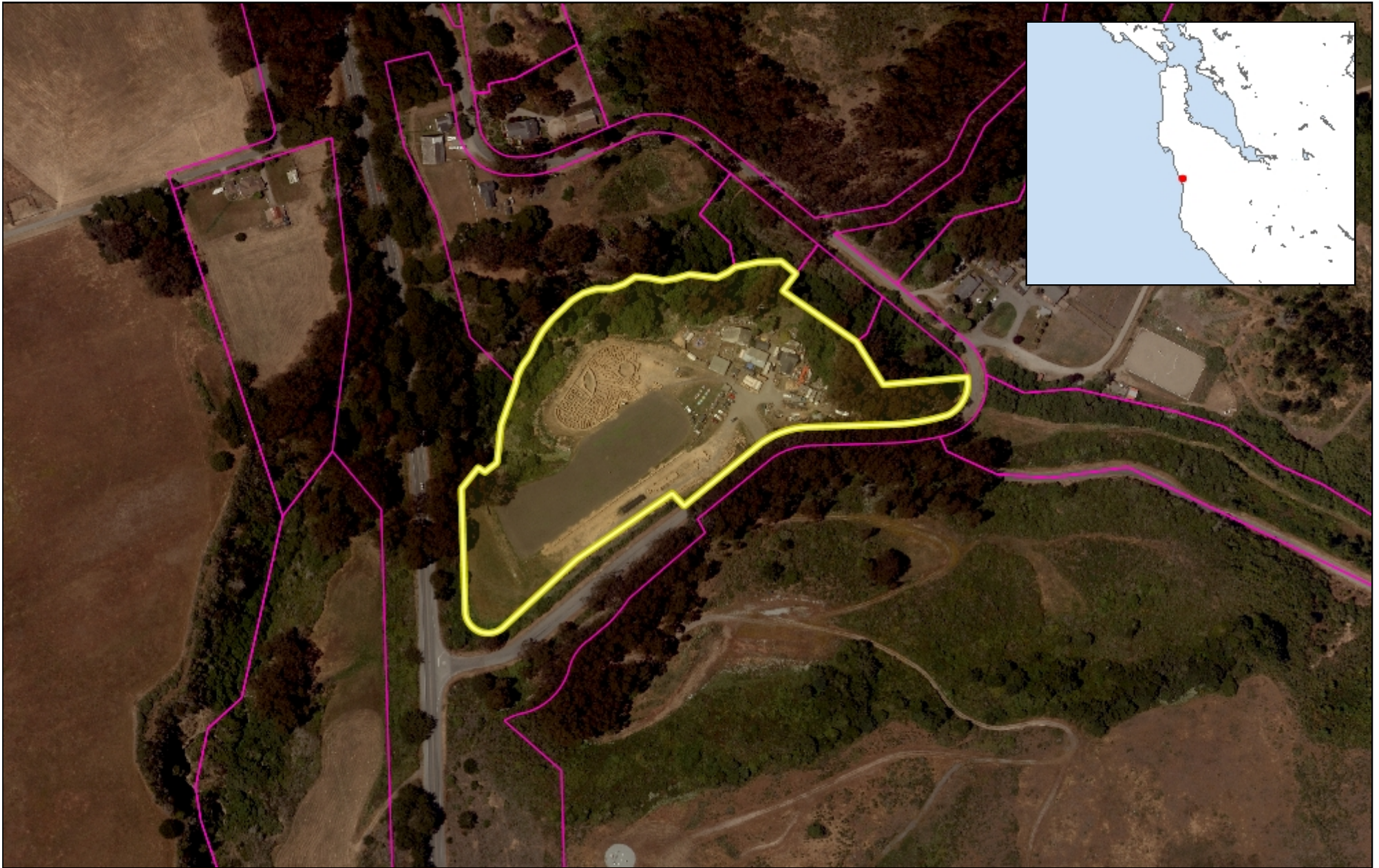

0.14 0 0.07 0.14 Miles

WGS\_1984\_Web\_Mercator\_Auxiliary\_Sphere  
© Latitude Geographics Group Ltd.

1:4,514 

This map is a user generated static output from an Internet mapping site and is for reference only. Data layers that appear on this map may or may not be accurate, current, or otherwise reliable.

**THIS MAP IS NOT TO BE USED FOR NAVIGATION**



COUNTY OF SAN MATEO - PLANNING AND BUILDING DEPARTMENT

# ATTACHMENT B



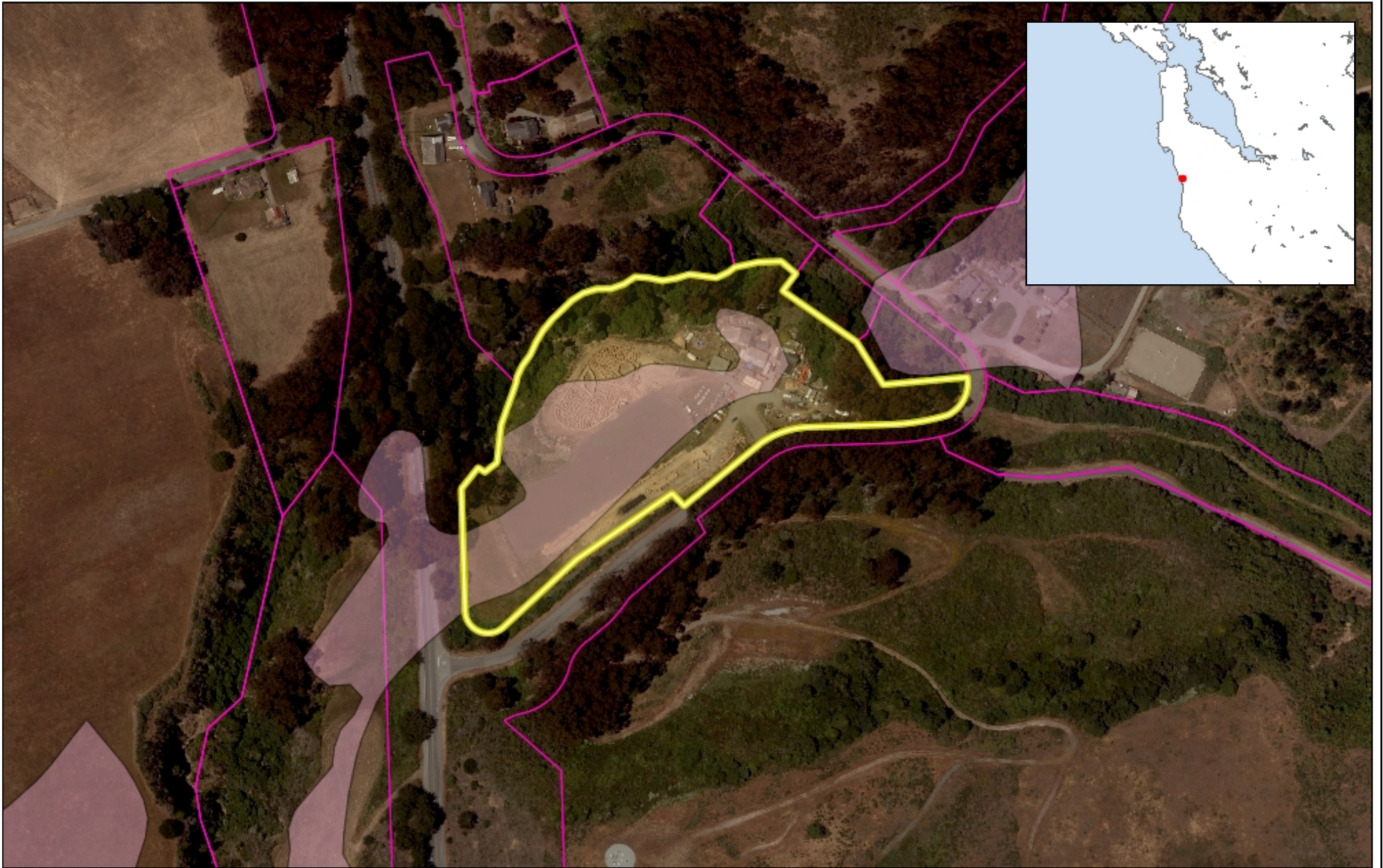

0.14 0 0.07 0.14 Miles

WGS\_1984\_Web\_Mercator\_Auxiliary\_Sphere  
© Latitude Geographics Group Ltd.

1:4,514



This map is a user generated static output from an Internet mapping site and is for reference only. Data layers that appear on this map may or may not be accurate, current, or otherwise reliable.

**THIS MAP IS NOT TO BE USED FOR NAVIGATION**



COUNTY OF SAN MATEO - PLANNING AND BUILDING DEPARTMENT

# ATTACHMENT C



**RECEIVED**

FEB 20 2020

San Mateo County  
Planning Division

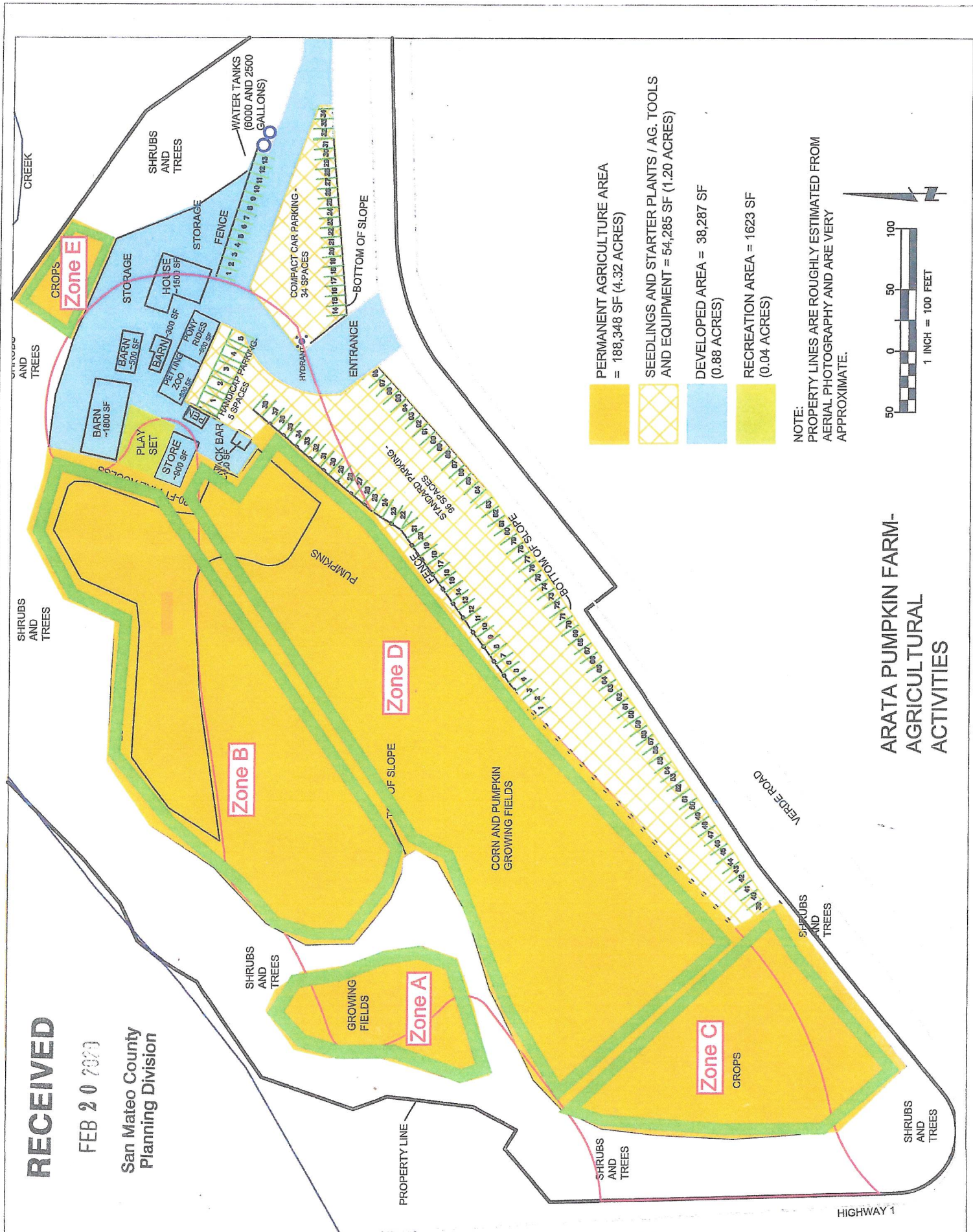

- PERMANENT AGRICULTURE AREA = 188,348 SF (4.32 ACRES)
- SEEDLINGS AND STARTER PLANTS / AG. TOOLS AND EQUIPMENT = 54,285 SF (1.20 ACRES)
- DEVELOPED AREA = 38,287 SF (0.88 ACRES)
- RECREATION AREA = 1623 SF (0.04 ACRES)

NOTE: PROPERTY LINES ARE ROUGHLY ESTIMATED FROM AERIAL PHOTOGRAPHY AND ARE VERY APPROXIMATE.

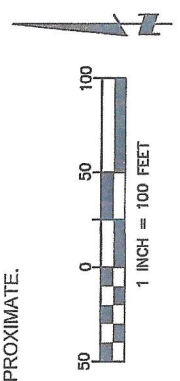

### ARATA PUMPKIN FARM- AGRICULTURAL ACTIVITIES



COUNTY OF SAN MATEO - PLANNING AND BUILDING DEPARTMENT

# ATTACHMENT D



**RECEIVED**

FEB 20 2020

San Mateo County  
Planning Division

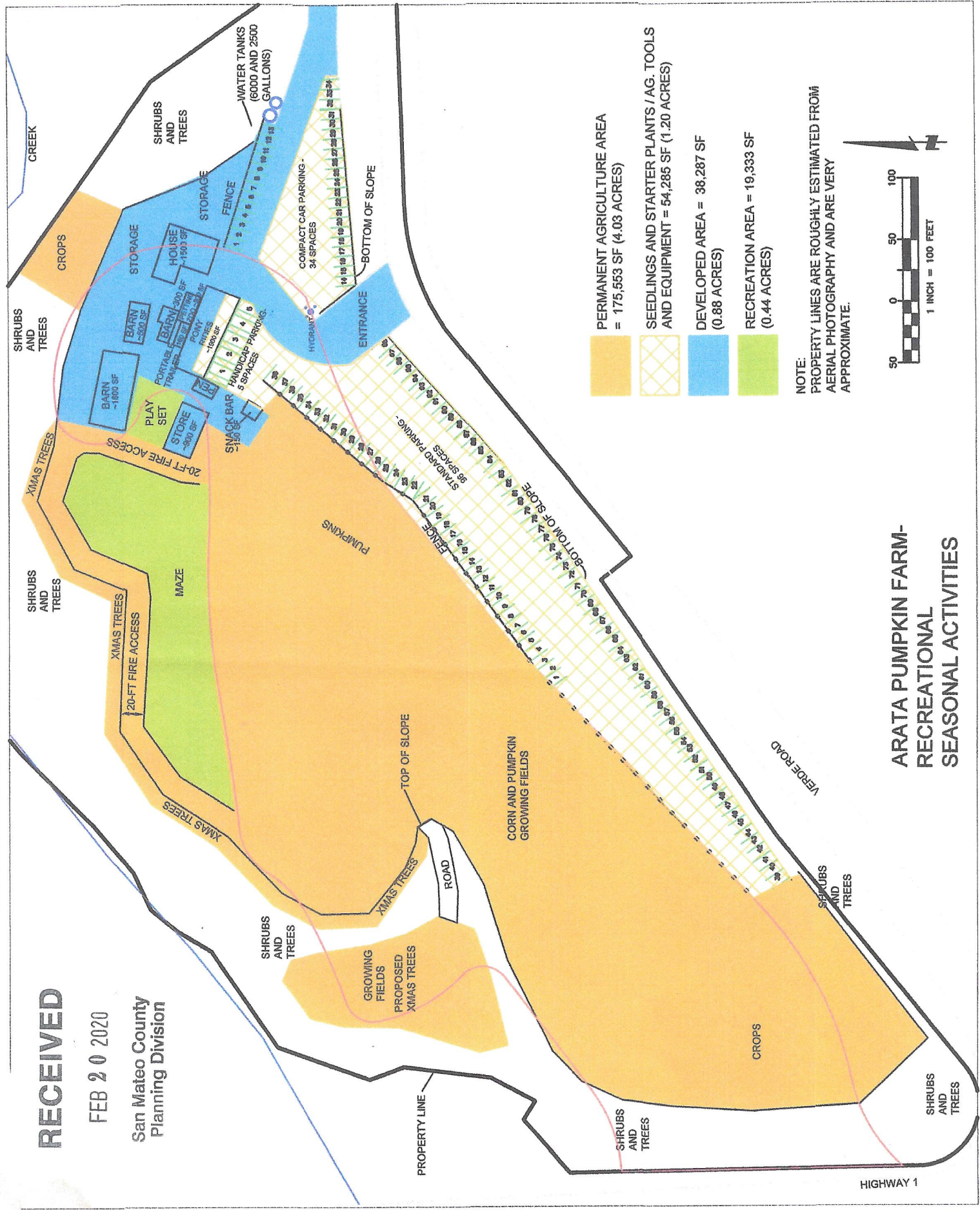

**ARATA PUMPKIN FARM-  
RECREATIONAL  
SEASONAL ACTIVITIES**



COUNTY OF SAN MATEO - PLANNING AND BUILDING DEPARTMENT

# ATTACHMENT E



PLN2015-00084

**RECEIVED**

JAN 10 2017

San Mateo County  
Planning and Building Department

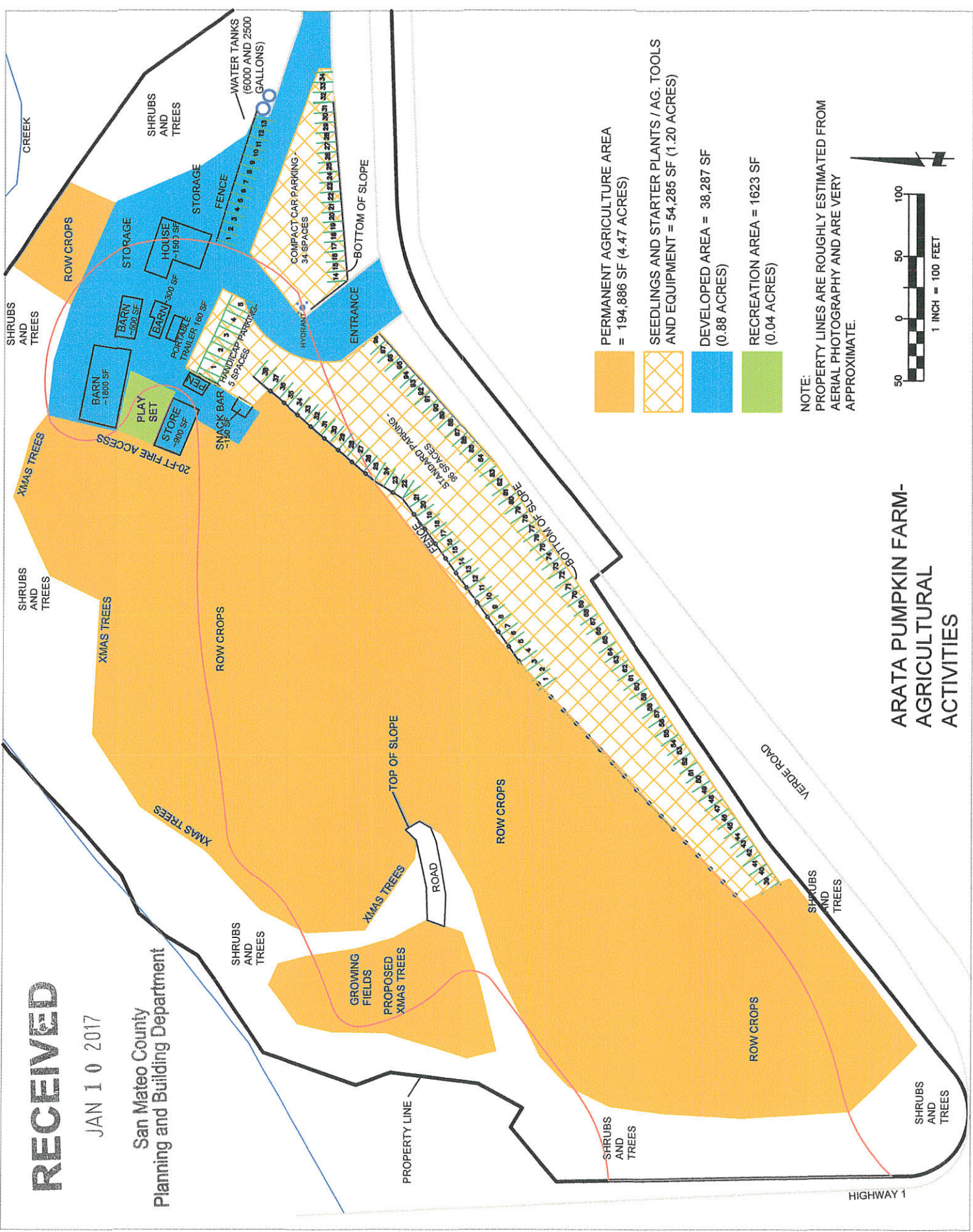

- PERMANENT AGRICULTURE AREA  
= 194,886 SF (4.47 ACRES)
- SEEDLINGS AND STARTER PLANTS / AG. TOOLS  
AND EQUIPMENT = 54,285 SF (1.20 ACRES)
- DEVELOPED AREA = 38,287 SF  
(0.88 ACRES)
- RECREATION AREA = 1623 SF  
(0.04 ACRES)

NOTE:  
PROPERTY LINES ARE ROUGHLY ESTIMATED FROM  
AERIAL PHOTOGRAPHY AND ARE VERY  
APPROXIMATE.

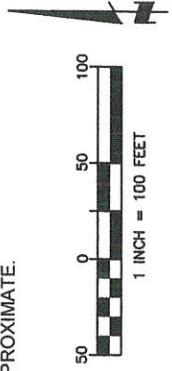

**ARATA PUMPKIN FARM-  
AGRICULTURAL  
ACTIVITIES**

HIGHWAY 1



COUNTY OF SAN MATEO - PLANNING AND BUILDING DEPARTMENT

# ATTACHMENT F



PLN2015-00084

**RECEIVED**

JAN 10 2017

San Mateo County  
Planning and Building Department

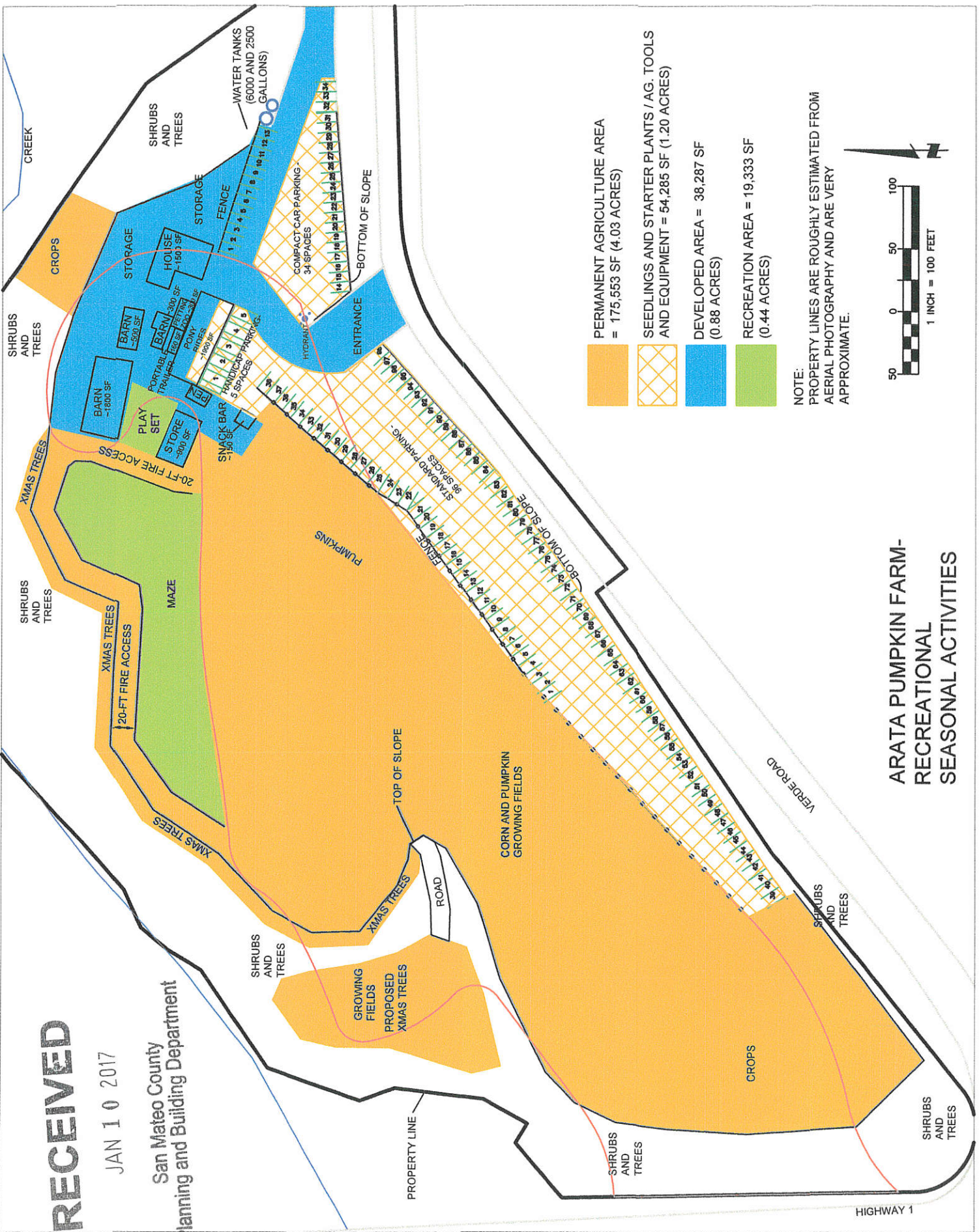

**ARATA PUMPKIN FARM-  
RECREATIONAL  
SEASONAL ACTIVITIES**



COUNTY OF SAN MATEO - PLANNING AND BUILDING DEPARTMENT

# ATTACHMENT G



May 10, 2017

Chris Gounalakis  
185 Verde Road  
Half Moon Bay, CA 94019

Dear Mr. Gounalakis:

Subject: **LETTER OF DECISION**  
File Number: PLN 2015-00084  
Location: 185 Verde Road, unincorporated Half Moon Bay  
APN: 066-310-080

On May 10, 2017 the San Mateo County Planning Commission considered a Renewal and Amendment of a Planned Agricultural District Permit, pursuant to Section 6350 of the San Mateo County Zoning Regulations, and a Coastal Development Permit, pursuant to Section 6328.4 of the San Mateo County Zoning Regulations, to allow seasonal commercial recreation activities at the Arata Pumpkin Farm located at 185 Verde Road approximately 4 miles south of the City of Half Moon Bay. This project is appealable to the California Coastal Commission.

Based on information provided by staff and evidence presented at the hearing, the Planning Commission approved the renewal and amendment of the Planned Agricultural District Permit and Coastal Development Permit, by making the revised required findings and adopting the conditions of approval listed in Attachment A.

Any interested party aggrieved by the determination of the Planning Commission has the right of appeal to the Board of Supervisors within ten (10) business days from such date of determination. The appeal period for this matter will end at **5:00 p.m. on May 24, 2017**.

The approval of this project is also appealable to the California Coastal Commission. Any aggrieved person may appeal this decision to the California Coastal Commission within 10 working days following the Coastal Commission's receipt of the notice of Final Local Decision. Please contact the Coastal Commission's North Central Coast District Office at (415) 904-5260 for further information concerning the Commission's appeal process. The County and Coastal Commission appeal periods are sequential, not concurrent, and together total approximately one month. A project is considered approved when these appeal periods have expired and no appeals have been filed.

Please direct any questions regarding this matter to Project Planner Rob Bartoli at 650-363-1857 or [rbartoli@smcgov.org](mailto:rbartoli@smcgov.org).



Sincerely,



Janneth Lujan  
Planning Commission Secretary

cc: Department of Public Works  
Environmental Health Department  
Building Inspection Department  
California Coastal Commission  
Coastside Fire Protection District



Attachment A

County of San Mateo  
Planning and Building Department

**FINDINGS AND CONDITIONS OF APPROVAL**

Permit or Project File Number: PLN 2015-00084

Hearing Date: May 10, 2017

Prepared By: Rob Bartoli  
Project Planner

Adopted By: Planning Commission

**FINDINGS**

Regarding the Mitigated Negative Declaration, Found:

1. That the proposed renewal and amendment is categorically exempt from environmental review pursuant to the California Environmental Quality Act (CEQA), Class 1, Section 15301 for continued operation of an existing facility involving negligible or no expansion of use.

Regarding the Planned Agricultural District Permit, Found:

2. That the project, as described and conditioned, conforms with the Planned Agricultural District regulations in accordance with Section 6350 of the San Mateo County Zoning Regulations as described in the staff report dated May 10, 2017 because no changes are proposed to the project other than the hours of operation which will not adversely affect the current and foreseeable use of the property for agricultural purposes.

Regarding the Coastal Development Permit, Found:

3. That the project, as described in the application and accompanying materials required by Section 6328.7 and as conditioned in accordance with Section 6328.14, conforms to the plans, policies, requirements and standards of the San Mateo County Local Coastal Program. Specifically, the applicable policies of the Agriculture Component, Sensitive Habitat Component, and the Visual Resources Component because the project scope remains consistent with the prior approval and that the hours of operations modification will not adversely affect the agricultural uses, potential sensitive habitats or visual resources.

**CONDITIONS OF APPROVAL**

Current Planning Section

1. This approval applies only to the proposal described in this report and submitted to and approved by the Planning Commission on May 10, 2017. Minor revisions or modifications may be approved by the Community Development Director if they are consistent with the intent of and in substantial conformance with the approval. Any other changes, modifications or additions shall require an amendment to the permit at a public hearing.

2. This permit shall be valid for **three (3)** years until May 10, 2020. The applicant shall file for a renewal of this permit six (6) months prior to expiration with the Planning Department by submitting the applicable application forms and payment of applicable fees, if continuation of this use is desired. Renewal/amendment of the permit shall be subject to review by the Agricultural Advisory Committee and the Planning Commission. Complaints received by the Planning and Building Department shall be considered by the Planning Commission in its review of any renewal or amendment of the permit.

This permit shall be subject to annual administrative reviews which shall include annual inspections scheduled by the applicant/property owner with Planning staff and completed prior to September 30 of each year.

3. The applicant shall install a durable sign near or on the snack bar, outside of areas used for agricultural production, which provides contact information (name, phone number, and email address) of the applicant's designated representative who shall be responsible for responding to complaints regarding project operation. The sign shall be posted from August 1 to November 1, each year. The sign shall also include contact information to direct complaints to a designated County representative (Ana Santiago, Code Compliance Section, 650/363-4825). The complaint would be investigated within four (4) working days of the filing date of the complaint and, if confirmed, a violation case would be opened, written correspondence would be sent to the applicant/owner, and enforcement would be escalated according to standard procedure, until the violation is corrected to the satisfaction of the Community Development Director. The applicant shall submit the precise wording of the sign for review and approval by the Community Development Director at least two (2) weeks prior to August 1 of each year.
4. The applicant/property owner shall maintain native vegetation outside of agricultural production areas to screen all aspects of the commercial recreation use (i.e., hay maze, jump houses, etc.) such that structures are minimally visible from Cabrillo Highway, to the extent feasible, in accordance with a planting plan that shall be submitted for review and approval by the Community Development Director at least two (2) weeks prior to August 1, 2017.
5. The property owner is responsible for maintaining the health of intervening vegetation necessary for screening all structures associated with commercial recreation as viewed from the Cabrillo Highway. Per Section 6324.2 of the Zoning Regulations (Site Design Criteria), the removal of any mature trees (those over 55 inches in circumference) would be subject to the issuance of a PAD Permit.
6. The petting zoo shall be limited to animals traditionally associated with California coastal agriculture (i.e., sheep, goats, chickens, etc.).
7. Any increase in the number of ponies beyond five (5) ponies will require an application for the keeping of confined animals. The applicant shall comply with the approved manure and stormwater management plan per the San Mateo County Confined Animal Regulations.
8. The applicant shall locate all uses according to the site plans submitted by the applicant (Attachment C). Compliance with this requirement shall be demonstrated to the satisfaction of the Community Development Director prior to the start of project operation.



9. All structures (i.e., haunted barn and sales kiosk) and signage associated with the commercial recreation use are required to maintain the same earth and vegetative tones as the predominant colors of the site, as determined by and to the satisfaction of the Community Development Director.
10. The applicant/property owner shall maintain the gravel-surface parking lot, maze structures, and other development such that pollutants (including trash and sediment) do not enter Lobitos Creek or any right-of-way.
11. Mitigation Measure 6: The applicant/property owner shall strictly adhere to the following hours/days of operation:

**July 1 - November 1 (except October)**

Monday - Friday: 9:00 a.m. - 6:00 p.m.

Saturday: 9:00 a.m. - 9:00 p.m.

Sunday: 9:00 a.m. - 8:00 p.m.

**October**

Monday - Thursday: 9:00 a.m. - 7:00 p.m.

Friday and Saturday: 9:00 a.m. - 10:00 p.m.

Sunday: 9:00 a.m. - 7:00 p.m.

Violation of the hours of operation, as confirmed by Planning staff, may result in the revocation of this permit.

12. Mitigation Measure 7: During the Halloween/Pumpkin Season (September 15 to October 31), the applicant/property owner is permitted to temporarily install up to four (4) directional traffic signs, maximum 2 feet x 3 feet each in size, which may be visible from Cabrillo Highway. Such signs shall be installed on-site and not in the public right-of-way and shall be of the same earth and vegetative tones as the predominant colors of the site, as determined by and to the satisfaction of the Community Development Director. All signage shall be removed from the site by November 1. No signage shall be allowed on or along Cabrillo Highway.
13. Mitigation Measures 2 and 4: During the Halloween/Pumpkin Season (September 15 to October 31), the applicant/property owner shall employ at least three (3) parking attendants to assist in the facilitation of pedestrian and vehicular movement along Cabrillo Highway and Verde Road, and entering and exiting the site. The applicant/property owner shall be responsible to ensure that no parking or standing occurs on or along Cabrillo Highway or Verde Road.
14. The applicant/property owner is encouraged to explore off-site parking opportunities (i.e., a formal off-site parking agreement with property owner(s) in the area), to ease parking challenges at the site. Off-site parking shall comply with permitting requirements of the Planned Agricultural District (PAD) Coastal Development (CD) Zoning Districts.
15. At the end of the Halloween/Pumpkin Season on November 1, operation of all recreational activities will cease immediately and, within 30 days, the applicant/property owner shall deconstruct the hay maze. Hay that is stacked for future use shall be clustered and located outside of prime soil areas and within areas minimally visible from Highway 1.

16. The applicant/property owner must commit areas of the property to active agricultural production, according to the timeframes in the table below:

Crop Production by Zone, as Shown on Map							
	A	B	C	D	E	F	
November	Christmas Trees	Fallow/Cover Crop					Seedlings/ Starter Plants
December							
January							
February							
March		Peas*/ Stone Pine s*/ Christm as Tree s/ Fava Bea ns	Fava Bea ns	Corn/ Pumpk ins*	Pumpkin s	None (Parking)	
April							
May							
June							
July							
August							
September	Harvest/Sales					None (Parking)	
October							
* Entire zone planted, excluding areas of the hay maze for the month of August. Note: Crop type may change, as long as an active agricultural use is maintained.							

17. The applicant/property owner shall manage trash and debris by providing covered containers placed in locations throughout publicly accessible areas of the property. Trash shall be removed in a timely manner such that there is no trash overflow.
18. The use of flashing lights on the property is prohibited.
19. A building permit shall be obtained from the Building Inspection Section prior to any construction on the property, and all construction shall be in accordance with approved plans. No hay bale structure shall exceed 6 feet in height from grade.
20. The applicant shall apply for and obtain a farm-stand license from the Environmental Health Division for and prior to the operation of the store and sales kiosk. Copies of permits shall be submitted to the Current Planning Section. Depending on the extent of both food services and water use offered by Arata Farms during the recreation season, Arata Farms must remain in compliance with all directives of the San Mateo County Environmental Health Division and the California Department of Public Health - Drinking Water Division.



21. Additional demand on the existing septic system or the existing well to serve the commercial recreation use is subject to Environmental Health Division review and permitting.
22. The applicant/property owner shall apply for and obtain any required permits from Coastside Fire Protection District. Copies of permits shall be submitted to the Current Planning Section.
23. Off-premises commercial signs, brightly colored or illuminated, rotating, reflective, blinking, flashing or moving signs, and pennants or streamers are prohibited, per Local Coastal Program Policy 8.21 (*Commercial Signs*). Directional signs shall be simple, easy to read and harmonize with surrounding elements.
24. The property owner shall remove gravel and restore the quality of the soil in all parking areas on prime soil, as necessary to maintain the existing agricultural productivity of these soils, immediately upon the ceasing of seasonal operations as described in PLN 2015-00084, either by the applicant no longer pursuing such seasonal operations on the property or due to revocation of the permit by the County. The gravel parking area shall not be expanded from the area shown on the submitted map received by the County on January 10, 2017. Specific remediation actions shall be determined in consultation with an agricultural specialist familiar with County lands. Container farming is permitted within the existing gravel parking area during non-recreational months.
25. Mitigation Measure 1: The applicant/property owner shall utilize no more than 1.79 acres of the total undeveloped area of land for recreational activities. This permit does not allow any intensification or expansion of use beyond the scope of the approved project. All structures associated with the recreational use of the property (other than the barns, store, snack bar, and single-family dwelling) shall be removed, and the land made available for agricultural purposes, by November 7 of each year.
26. Mitigation Measure 3: The applicant/property owner shall maintain the 135 on-site parking spaces. All spaces shall be clearly marked with chalk prior to September 15; the applicant shall submit to the Planning Department for review and approval a parking management plan that includes placement of attendants and vehicular movement within the site. At no time shall vehicles be allowed to park along Cabrillo Highway or along areas of Verde Road where parking is prohibited.
27. Mitigation Measure 5: The applicant/property owner shall be responsible for ensuring that all visitors have left the premises within 30 minutes of the site activities' closing time.
28. Per LCP Policy 11.15(c)(2) (*Private Recreation and Visitor-Serving Facilities*), the property owner/applicant shall execute and record a deed restriction over the entire parcel and shall specify that: "Conversion of any portion of the commercial recreation facilities to a non-public, private, or member only use, or the implementation of any program to allow extended or exclusive use or occupancy of such facilities by an individual or limited group or segment of the public, shall require an amendment to the applicable permits." The applicant shall demonstrate compliance with this condition at least two (2) weeks prior to August 1, 2017.
29. The one bounce house shall be operated in compliance with the standards of the "Safe Inflatable Operators Training Organization" and/or other comparable best management practices for the safe operation of the bounce house.

30. The applicant shall comply with the Williamson Act contract, as amended by the Board of Supervisors on September 25, 2012. The contract allows for limited seasonal recreation uses, as listed in the contract. It should be noted that the contract does not permit the on-site sale of non-pre-packaged food.
31. During the recreation season, the applicant/property owner shall erect temporary fencing and signage to prevent public access to areas within 20 feet of the top of the creek bank. The signage shall contain verbiage directing the public to stay away from the Lobitos Creek. The signs and fence shall be self-anchored signs and shall minimize land disturbance.
32. Administrative annual reviews of PLN 2015-00084 shall occur prior to December 1 of each year of the permit to confirm that all conditions of approval have been met. The applicant shall pay the inspection fee per the San Mateo County Planning and Building Department fee schedule to cover staff costs to conduct the administrative reviews. If there are any significant compliance problems, these shall be reported to the Planning Commission.

#### Department of Public Works

33. All owners, employees, visitors and individuals otherwise associated with the property shall park on-site, or within the length of Verde Road approved by Cal-Fire and the Department of Public Works staff shown in Attachment J of the staff report. Parking along Verde Road shall accommodate a maximum of 58 parking spaces and maintain a minimum 20-foot wide paved road clearance. Applicant must discontinue use of on-street parking until Department of Public Works (DPW) requirements, including those listed below, have been met; otherwise, any on-street parking authorized by this permit will be void.

Prior to commencing any commercial recreation activities on the site, the applicant/property owner shall be required to: (1) submit a parking plan and traffic control plan to the Department of Public Works and (2) install on standard poles with temporary CA Manual on Uniform Traffic Control Devices (MUTCD) M26F "No Parking - Fire Lane" signs at 300-foot intervals along Verde Road, with the exception of the portion of road described above, subject to the approval of the DPW via an encroachment permit. The signage plan shall describe the location, type, color, size, and mounting of proposed signage to be located along Verde Road. The applicant/property owner is responsible for the cost of all improvements and long-term maintenance of improvements. Violation of parking restrictions, as confirmed by County staff, may result in the revocation of this permit. Temporary signs shall be removed by November 7.

The applicant/property owner shall monitor all parking associated with this project within the Verde Road right-of-way. The applicant/property owner shall coordinate with the Coastside Fire Protection District and the Department of Public Works to mark sections of Verde Road where parking is allowed, as well as the individual 58 parking spaces to promote efficient parking. As required by Condition No. 32, the applicant shall contact the County Sheriff's Office immediately if there are violations of the "No Parking" zones. Furthermore, as required by Condition No. 32, the applicant shall hire security guards and after-hour police/sheriff's officers to ensure that the "No Parking" zones are adequately enforced.



34. Prior to the start of operation, the applicant/property owner shall restrict parking on Verde Road by complying with the following requirements, subject to the approval of the Department of Public Works (non-compliance with this condition may result in the revocation of this permit):
- a. Prior to the start of operation each year, the applicant shall obtain a Special Events Road Closure/Encroachment Permit for Verde Road from the Department of Public Works and comply with all applicable requirements of the permit. The applicant shall submit a plan, subject to the Department of Public Works review and approval, to restrict parking within the closed-off section of Verde Road and ensure adequate pedestrian safety along Verde Road (no pedestrians are allowed on Cabrillo Highway). Issuance of the permit requires proof of authorization by the California Highway Patrol (CHP), the County Sheriff's Office, and Cal-Fire. The applicant shall pay the applicable fee to the Sheriff's Office for the adequate enforcement of the parking plan (hourly or bihourly passing checks and ticketing as necessary). For all weekends of the month of October, the applicant shall utilize a minimum of six (6) parking attendants to ensure adequate levels of enforcement. The Road Closure Permit will allow local traffic, parking of patrons along designated areas of Verde Road, and access by emergency vehicles. The applicant shall maintain a minimum road clearance of 20 feet for emergency vehicles at all times.
- b. At no time should street parking block driveways to properties or impede vehicles turning along Verde Road (i.e., at Lobitos Creek Cutoff). The applicant shall coordinate with a fire service representative to mark the limits of parking along Verde Road prior to October 1 of each year or commencement of venue operations, whichever is later.

#### Coastside Fire Protection District

35. Project must meet 2016 California Fire Code Sections 907.2.12, 907.2.12.1, 907.2.12.2, and 907.2.12.3, Special Amusement Parks. An automatic smoke detection system shall be provided in special amusement buildings in accordance with Sections 907.2.12.1 through 907.2.12.3.
36. The Haunted House must meet Appendix K Sections K101 through K103 of the 2016 California Fire Code and Coastside Fire District Ordinance #PI-011, Haunted Houses.
37. An approved automatic fire system meeting the requirements of NFPA-13 shall be required to be installed for use of the barn as a haunted barn. A fire sprinkler plan shall be received, reviewed, and approved by the Coastside Fire Protection District prior to the use of the haunted barn. Plans shall be submitted to the San Mateo County Building Inspection Section for review and approval by the Coastside Fire Protection District. The sprinkler system design shall be based on an at least Ordinary-Group 2 classification or higher classification based on stored commodity. Please provide information as to the commodity. Unobstructed fire sprinkler coverage shall extend to all areas in the occupancy. Any areas creating compartmentalization due to new walls shall have additional sprinkler heads installed to provide unobstructed coverage.
38. Along with the automatic fire sprinkler system, this project is required to install fire sprinkler hardware (Post Indicator Valve, Fire Department Connect, and Exterior Bell). Plans shall be submitted, reviewed, and approved by the Coastside Fire Protection District.

39. A Knox Box, Knox Key Switch, or Knox Padlock shall be installed to allow rapid response of emergency vehicles onto your property in case of a fire or medical emergency. For an application or further information, please contact the San Mateo County Fire Marshal's Office.
40. All buildings that have a street address shall have the number of that address on the building, mailbox, or other type of sign at the driveway entrance in such a manner that the number is easily and clearly visible from either direction of travel from the street. New residential buildings shall have internally illuminated address numbers contrasting with the background so as to be seen from the public way fronting the building. Residential address numbers shall be at least 6 feet above the finished surface of the driveway. An address sign shall be placed at each break of the road where deemed applicable by the Coastside Fire Protection District. Numerals shall be contrasting in color to their background and shall be no less than 4 inches in height, and have a minimum 1/2-inch stroke. Remote signage shall be a 6 inches x 18 inches green reflective metal sign.
41. Building plans shall include the proper exiting system (panic hardware and exit signs), including listing of hardware, as per the current California Building and Residential Codes. The system must be installed and inspected, prior to Coastside Fire Protection District final approval of a building permit.
42. All Occupancy Loads will be set by the San Mateo County Building Inspection Section and will be supported and enforced by the Coastside Fire Protection District. Any room having an occupant load of 50 or more, where fixed seats are not installed, and which is used for a classroom, assembly, or similar purpose, shall have the capacity of the room posted in a conspicuous place.
43. A fire alarm system shall be installed meeting California Fire and Building Codes and NFPA-72.
44. Portable fire extinguishers with a minimum rating of 2A-10BC are required to be placed throughout your project. Contact a licensed/certified fire extinguisher company for proper placement of the required extinguishers. Documentation is required on building plans at the building permit application stage. Proper installation is required prior to Coastside Fire Protection District final approval for the building permit.

#### Environmental Health Division

45. For all events where food or beverages are distributed to the public, Arata Farms must obtain timely permits from the Environmental Health Division Food Program and comply with the California Retail Food Code. Foods must be stored and distributed in accordance to the California Retail Food Code. It should be noted that the on-site sale of non-pre-packaged food is not permitted at this site. Potable water must be available in sufficient quantity for handwashing and food utensil washing. Lavatories for food/beverage handlers must be located within 200 feet of every food/beverage distribution site. Trash must be contained to as not becoming an attractive nuisance to vermin. Petting zoos shall have hand wash stations for patrons.
46. Applicant shall provide information on the proposed number of portable toilets and supporting documentation or calculations demonstrating the proposal is an adequate number of portable toilets for the commercial recreational activities. The applicant must identify the frequency (number of days in a year) of the limited events. The applicant



shall demonstrate that adequate potable water supply is available to patrons and employees.

Building Inspection Section

47. A building permit is required for the snack building and play set.



**COUNTY OF SAN MATEO - PLANNING AND BUILDING DEPARTMENT**

**ITEM**

**10**

**COUNTY OF SAN MATEO  
PLANNING AND BUILDING DEPARTMENT**

**DATE:** October 19, 2020

**TO:** Agricultural Advisory Committee

**FROM:** Olivia Boo, Planning Staff, 650/363-1818

**SUBJECT:** Coastal Development Permit and a Planned Agricultural Permit pursuant to Sections 6328.4 and 6352 of the County Zoning Regulations to propose four new farm labor housing units, fire turnaround, a new septic system, and three new 5,000-gallon water tanks. There is minimal grading proposed, no tree removal and minimal vegetation removal. The property is located at 1800 Higgins Canyon Road in the unincorporated Half Moon Bay area of San Mateo County. The project is appealable to the California Coastal Commission.

County File Number: PLN2019-00488 (Giusti)

**PROPOSAL**

The applicant is proposing to construct four new farm labor housing units, fire turnaround, a new septic system, and three new 5,000-gallon water tanks (10,000 gallons for fire suppression; 5,000 gallons for domestic) to the existing Giusti farm. A minimal amount of vegetation will be removed, and 14 cubic yards of grading is proposed. The farm grows row crops of Brussel sprouts.

**DECISION MAKER**

Planning Commission

**QUESTIONS FOR THE AGRICULTURAL ADVISORY COMMITTEE**

1. Will the development have any negative effect on surrounding agricultural uses? If so, can any conditions of approval be recommended to minimize any such impact?
2. What position do you recommend that Planning staff take with respect to the application for this project?

**BACKGROUND**

Report Prepared By: Olivia Boo, Project Planner, 650/363-1818

Applicant: Joanne Giusti

Owner: Giusti Family, LLC

Location: 1800 Higgins Canyon Road, Half Moon Bay

APN: 064-370-210

Parcel Size: 3.75 acres.

Existing Zoning: PAD/CD (Planned Agriculture District/Coastal Development)

General Plan Designation: Agriculture

Local Coastal Plan Designation: Agriculture

Williamson Act: Not contracted.

Existing Land Use: Agriculture use, brussel sprouts row crops, existing farm house and eight various agriculture buildings for offices, storage sheds and farm work. The parcel is improved with an existing ranch house, an improved main road (Higgins Canyon Road) off of Cabrillo Highway, and a residence and seven various agriculture buildings. The property is approximately 3,600 feet east of Cabrillo Highway.

Water Supply: The property is currently served by Coastside County Water District (CCWD) public water system through a legacy connection.

Sewage Disposal: A new septic system is proposed as part of this project.

Flood Zone: Flood zone X (area of minimal flood); Community Panel Number 06081C0260E, effective October 16, 2012.

Environmental Evaluation: Categorically exempt pursuant to Section 15302, Class 3 construction of new small structures.

Setting: The parcel is improved with an existing ranch house, an improved main road off of Cabrillo Highway, brussel sprouts row crops, eight various agriculture buildings for offices, storage sheds and farm work.

Chronology:

<u>Date</u>	<u>Action</u>
January 15, 2020	- Application received.

- August 6, 2020 - Application deemed complete.
- October 19, 2020 - Agricultural Advisory Committee meeting
- October 28, 2020 - Planning Commission

*Will the project be visible from a public road?*

The project parcel is flat, the proposed farm labor homes will be located on the east side of Giusti ranch, close to Arroyo Leon Creek. The project parcel is located 1,500 feet east of Cabrillo Highway and will not be visible from the highway. The farm labor housing units will be located behind all of the existing agricultural structures on site, which will be approximately 200 feet from Higgins Canyon Road and will be minimally visible, if at all, from Higgins Canyon Road.

*Will any habitat or vegetation need to be removed for the project?*

Minor vegetation is proposed to be removed to locate four new farm labor housing units on site. Approximately half of the flat parcel is already disturbed as the property has on going agricultural use with eight existing agricultural buildings and row crops of Brussel sprouts. The project site consists of the row crops and bare compacted earth. The existing vegetation consists of low growing wild grasses/ruderal weeds as noted by the submitted biologist report prepared by the San Mateo Resource Conservation District. The County Geographic Information System (GIS) indicates no Federal endangered species noted on the parcel, however there are potential State endangered species that may be impacted. The submitted biologist report states riparian habitat exists adjacent to the property, to the east of the proposed four farm labor housing units. Potential impacts will be indirect through sediment and noise. The biologist report recommends standard erosion control measures and that construction be scheduled at times when impacts will be minimized. The project will include standard Best Management Practices (BMP'S) during and after construction. The riparian area consists of willows and alder. It may support birds protected by the Bird Migratory Act. The direct impact may be from construction noise. A CNDDDB (California Natural Diversity Database) survey shows no fully protected species or species of special concern within a quarter mile of the project boundary besides the Western bumble bee and Steelhead trout.

*Is there prime soil on the project site?*

The San Mateo County Geographic Information System (GIS) indicates the entire parcel contains prime soils, Land Capability Classification of Class 1 and Storie Index of Grade 1, thus there is no option to avoid impacting prime soils. Proposed development will occur in the disturbed areas of the farm center and not within the active agricultural field in the northern portion of the parcel, thus no or minimal additional conversion of soils is proposed.

## DISCUSSION

### A. KEY ISSUES

Planning staff has reviewed this proposal and has concluded the following:

#### 1. Compliance with Planned Agricultural District (PAD) Regulations

The project complies with the applicable development standards and requirements, discussed below:

##### a. Development Standards

As shown in the table below, the project conforms to Section 6458 and 6359 of the San Mateo Zoning Regulations, which regulate the height and setbacks of structures.

Development Standard	Required	Proposed
Minimum Building Site	N/A	3.82 acres (existing)
Minimum Side Yard	20 ft.	140 ft. (Left side) 60 ft. (Right side)
Minimum Front Yard	30 ft.	200 ft.
Minimum Rear Yard	20 ft.	190 ft.
Maximum Building Height	36 ft.	14 ft. 4 inches Water tanks 7.5 ft.

##### b. PAD Requirements

The project conforms to the substantive criteria for the issuance of a PAD permit, as applicable and outlined in Section 6355 of the Zoning Regulations. As proposed and conditioned the project conforms to the following policies:

##### General Criteria

1. *The encroachment of all development upon land which is suitable for agricultural uses shall be minimized.*

The San Mateo County Geographic Information System (GIS), shows the entire parcel consists of prime soils, thus there is no option to prevent land conversion. The farm labor housing units and the proposed septic system expansion are proposed

adjacent and clustered with the existing eight agriculture structures on site within the farm center, thus minimizing impacts as much as possible. The remainder of the land continues to be available for row crops which are located in the northern portion of the parcel. Per Section 6353.A.2 of PAD Regulations, farm labor housing maybe permitted on prime agricultural land provided there are no alternative building sites on the parcel.

2. *All development permitted on a site shall be clustered.*

See response to b.1., above.

3. *Every project shall conform to the Development Review Criteria contained in Chapter 20A.2 of the San Mateo County Ordinance Code.*

The project, as proposed and conditioned, conforms to the following applicable Development Review Criteria of Chapter 20A.2 of the San Mateo County Ordinance Code.

Section 6324.1 (*Environmental Quality Criteria*), Section 6324.2 (*Site Design Criteria*) and Section 6325.2 (*Primary Fish and Wildlife Habitat Areas Criteria*) seek to cluster development, minimize grading and changes in vegetative cover, locate development so that it is subordinate to the pre-existing character of the area and protect primary wildlife habitat areas. The farm labor housing units will be located behind the seven existing agricultural buildings as well as the single-family residence, thus the farm labor housing units will be minimally visible, if at all, from Higgins Canyon Road. The parcel is flat with minimal grading, approximately 14 cubic yards, proposed for the farm labor housing units, the new septic system, three new water tanks, and new fire turnaround. No tree removal is proposed. Fourteen (14) cubic yards of grading is proposed, which includes 7 cubic yards of cut and 7 cubic yards of fill. The biologist report did not find any unique, rare or endangered species within the project area. Riparian habitat does exist adjacent, along the eastern property line east of the location for the proposed four farm labor housing units and 50 feet east of the project location. Recommended erosion control measures, best management practices, and construction scheduling will minimize potential impacts to sensitive habitats.

## Water Supply Criteria

4. *Adequate and sufficient water supplies needed for agricultural production and sensitive habitat protection in the watershed are not diminished.*

The property's domestic water is provided by Coastside County Water District. With the proposed new four farm labor housing units, the Environmental Health department has reviewed the project and issued conditional approval.

The water storage tanks and fire turnaround improvements are required by County Fire. One new 5,000-gallon water storage tank will be reserved for domestic water with the two remainder 5,000-gallon water tanks to be reserved fire suppression purposes only.

### c. Criteria for the Conversion of Prime Agricultural Lands

The PAD Regulations allow the conversion of prime agricultural land permitted by a PAD permit when the following can be demonstrated.

1. *No alternative site exists on the parcel for the use.*

The entire parcel consists of prime soils and the land is flat. The project parcel does support commercially viable agricultural operations of existing row crops brussel sprouts and the project proposes to further facilitate and continue the agricultural use of the property. The one non-agricultural use on the property is the existing single-family residence within the farm center.

2. *Clearly defined buffer areas are provided between agricultural and non-agricultural uses.*

The property has supported the row crop Brussel sprouts for 71 years with most of the buildings constructed in 1900. The house was built in the 1870's. The property will continue to be used for row crop brussel sprouts. The existing and proposed development will be within the farm center, thus, maintaining the buffer between the farm center and ongoing agricultural uses.

3. *The productivity of an adjacent agricultural land will not be diminished.*

The project proposes four new farm labor housing units, three new water storage tanks, an expanded septic system and fire



turnaround near and within the developed portion of the parcel. The project will not diminish the agricultural productivity of any adjacent land or parcels as the project is bordered by riparian habitat/Arroyo Leon Creek to the east, the Historical James Johnston House directly south across Higgins Canyon Road which is owned by the City of Half Moon Bay. Peninsula Open Space Trust owns the parcel the remainder parcels surrounding the Giusti farms property. The project site has approximately 1-acre of Brussel sprout row crops and Giusti grows another 120 acres of Brussel sprouts on the adjacent parcel (west and contiguous) of Giusti farms. None of the adjacent parcels will be impacted by the added farm labor housing units. The farm laborers will benefit from the on-site farm labor housing while they work on Giusti farms.

4. *Public service and facility expansions and permitted uses will not impair agricultural viability, including be increased assessment costs or degraded air and water quality.*

The proposed farm labor housing units will provide on-site residential housing for the farm laborers who will work at the Giusti farm. The three water tanks will store domestic water supply for the laborers and provide adequate fire suppression. The project will result in facilitating needed housing for agriculture workers and safer conditions.

## 2. Compliance with Local Coastal Program (LCP) Policies

The project complies with the following applicable LCP Policies:

### a. Land Use Component

Policy 1.8 (*Land Uses and Development Densities in Rural Areas*) new development in rural areas shall not: (1) have significant adverse impacts, either individually or cumulatively, on coastal resources and (2) diminish the ability to keep all prime agricultural land and other land suitable for agriculture (as defined in the Agriculture Component) in agricultural production.

The proposed farm labor housing units and water tanks would have minimal impact on coastal resources, including sensitive habitat, wetland, riparian corridor and scenic views, as conditioned. The housing units will be clustered near the existing seven agricultural buildings, located behind the agricultural buildings where visual impacts are minimized and impacts to water resources and sensitive habitats are minimized as discussed under Section 6324.1. Clustered

with the existing structures, the farm labor housing units will not significantly diminish prime soils suitable for agriculture since the farm center is already a disturbed area. The water tanks will be dark olive green or black in color to blend with the surrounding area and the minimal earthwork and vegetation removal will ensure on that necessary to construct the development.

b. Agricultural Component

LCP Policy 5.5(a) and (b) (*Permitted Uses on Prime Agricultural Lands Designated as Agriculture*) and 5.8(a)(1) (*Conversion of Prime Agricultural Land Designated as Agriculture*) conditionally permit farm labor housing on prime soils and water storage tanks when related to agriculture and prohibits the conversion of prime agricultural land within a parcel unless it can be demonstrated that no alternative exists. The parcel is completely prime soils with no alternative to locate the structures without converting prime soils. The location of the new structures is also necessary to protect the riparian habitat so that sensitive habitat is not diminished and to preserve as much available land for row crops.

c. Sensitive Habitat Component

Policy 7.3 (*Protection of Sensitive Habitats*) seeks to protect sensitive habitats from adverse impacts caused by development.

The proposed four farm labor housing units will be the closest structures to the riparian areas, with a distance of over 50 feet from the edge of riparian. The remainder construction and project scope, expanded septic system, new fire turnaround and three new water storage tanks will be over 100 feet from the edge of riparian. Potential impacts will be indirect through sediment and noise. The biologist report recommends standard erosion control measures and that construction be scheduled at times when impacts will be minimized. With the BMP's and recommendations as prescribed by the biologist, the riparian area will not be significantly impacted.

## ATTACHMENTS

- A. Plans
- B. Farm labor housing unit specification
- C. Water take specification sheet
- D. Site Photos



COUNTY OF SAN MATEO - PLANNING AND BUILDING DEPARTMENT

# ATTACHMENT A

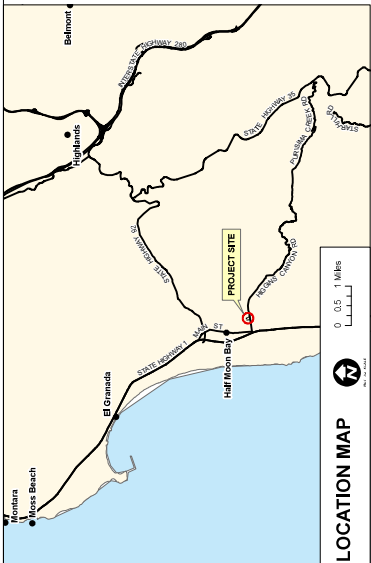

**LOCATION MAP**



**PROJECT DESCRIPTION:**  
The project is located on a 3.75 acre parcel along Higgins Canyon Road about 1/2 mile east of Highway 1 in San Mateo County, California.

The project proposes to improve the farm by installing four new trailers for farm labor housing, exotic beach fields for the new housing units, and three 5,000 gallon water tanks. The farm labor housing includes two (2) three bedroom units, one (1) two bedroom unit, and one (1) one bedroom unit. The project will utilize the existing driveway off Higgins Canyon Road.

Only minor grading of the project site is required to level out existing gravel pads, place additional aggregate base and gravel on steep slopes. Retention, proposed cuts and fills will be negligible. NO cuts or fills will occur on slopes steeper than 20 percent.

**GRADING VOLUMES:**  
CUT (Aggregate base rock): 7 cy max  
FILL (Aggregate base rock): 7 cy max

**LOCATION**  
GUSTI FARMS  
8001 HIGGINS CANYON ROAD  
HALF MOON BAY, CA 94019  
SAN MATEO COUNTY  
APN: 064-0370-210

- SHEET INDEX**
- C1 TITLE SHEET, EXISTING SITE PLAN, FIRE NOTES**
- C2 SITE PLAN**
- C3 GRADING DRAINAGE AND EROSION CONTROL PLAN**
- C4 CONSTRUCTION BEST MANAGEMENT PRACTICES**

**CONTACTS**

**ENGINEERING GEOLOGIST/PLANNING**  
PREP  
TIMOTHY C. BEST, CEG  
10000 VIA VERDE STREET  
SANTA CRUZ, CA 95060  
PHONE: (850) 755-3965  
EMAIL: GUSTIFARMS@ATT.NET  
CONTACT: JOHN GUSTI

- FIRE NOTES**
- Smoke detectors shall be installed as per the California Building Code. Smoke Free Medical Facilities and Fire Department 2016-01, 2016-01, California Fire Code 904.1.2. Smoke detectors shall be installed as follows:
    - Smoke detectors shall be installed in each sleeping unit.
    - Smoke detectors shall be installed in each living unit.
    - Smoke detectors shall be installed in each kitchen.
    - Smoke detectors shall be installed in each bathroom.
  - New residential buildings shall have a minimum fire alarm device area of 4.5 square feet, 5.0 sq. ft. above 4.5 sq. ft. The minimum net clear, unobstructed height shall be 24 inches. The minimum net clear, unobstructed height shall be 20 inches. Finished wall height shall be not more than 44 inches above the finished floor. (CFC 1003).
  - New residential buildings shall have internally illuminated address numbers consisting with the background so as to be seen from the street sign facing the building. The illuminated address numbers shall be at least 3/8 inch high. The address numbers shall be at least 4 inches high. Address numbers shall be at least 3/8 inch high. The address numbers shall be at least 4 inches high. Address numbers shall be at least 3/8 inch high. The address numbers shall be at least 4 inches high.
  - The building is a Very High Fire Hazard Occupancy Zone and will require a Class A roof.
    - As per Coastside Fire District Ordinance 2015-01, the roof covering of every new building or structure shall be Class A.
    - As per Coastside Fire District Ordinance 2015-01, the roof covering of every new building or structure shall be Class A.
    - As per Coastside Fire District Ordinance 2015-01, the roof covering of every new building or structure shall be Class A.
    - As per Coastside Fire District Ordinance 2015-01, the roof covering of every new building or structure shall be Class A.
  - The installation of an approved smoke detector is required on all WOOD BURNING chimneys.
    - The installation of an approved smoke detector is required on all WOOD BURNING chimneys.
    - The installation of an approved smoke detector is required on all WOOD BURNING chimneys.
    - The installation of an approved smoke detector is required on all WOOD BURNING chimneys.
    - The installation of an approved smoke detector is required on all WOOD BURNING chimneys.

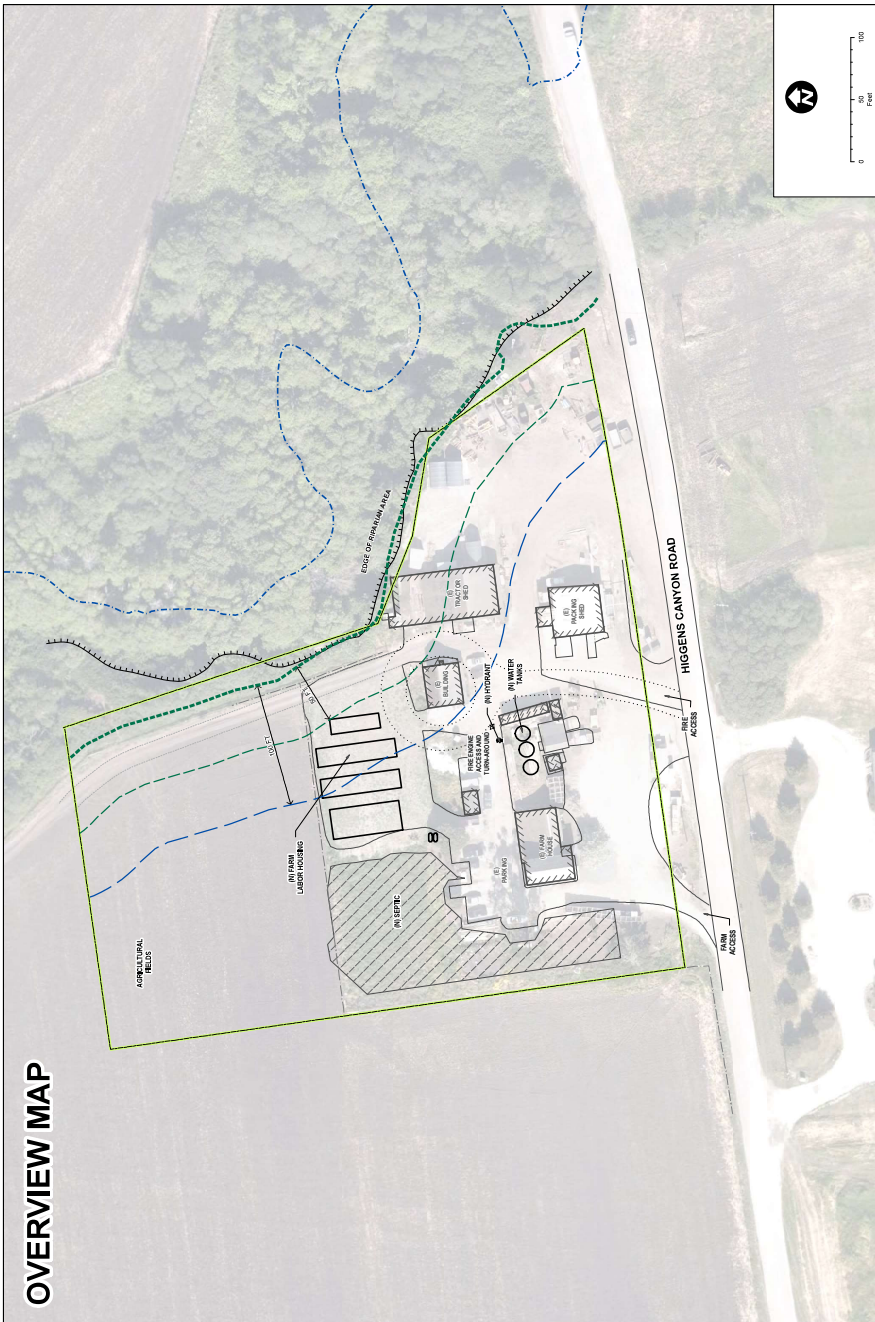

### TYP. THRUST BLOCK @ HYDRANT

**MATERIALS:**  
1. CONCRETE SHALL BE 4,000 PSI STRENGTH (CY-1) WITH NO. 4 REINFORCING BARS AT 18" ON CENTER.  
2. 6" DIA. HYDRANT SHALL BE 60,000 PSI YIELD STRENGTH.  
3. 6" DIA. HYDRANT SHALL BE 60,000 PSI YIELD STRENGTH.  
4. 6" DIA. HYDRANT SHALL BE 60,000 PSI YIELD STRENGTH.

### NEW WET-DRAFT HYDRANT & SUPPLY PIPE

**MATERIALS:**  
1. HYDRANT SHALL BE 6" DIA. HYDRANT SHALL BE 60,000 PSI YIELD STRENGTH.  
2. HYDRANT SHALL BE 6" DIA. HYDRANT SHALL BE 60,000 PSI YIELD STRENGTH.  
3. HYDRANT SHALL BE 6" DIA. HYDRANT SHALL BE 60,000 PSI YIELD STRENGTH.  
4. HYDRANT SHALL BE 6" DIA. HYDRANT SHALL BE 60,000 PSI YIELD STRENGTH.

### FOR UP TO 50' REND

**MATERIALS:**  
1. HYDRANT SHALL BE 6" DIA. HYDRANT SHALL BE 60,000 PSI YIELD STRENGTH.  
2. HYDRANT SHALL BE 6" DIA. HYDRANT SHALL BE 60,000 PSI YIELD STRENGTH.  
3. HYDRANT SHALL BE 6" DIA. HYDRANT SHALL BE 60,000 PSI YIELD STRENGTH.  
4. HYDRANT SHALL BE 6" DIA. HYDRANT SHALL BE 60,000 PSI YIELD STRENGTH.

### FOR 12" INTERSECTION

**MATERIALS:**  
1. HYDRANT SHALL BE 6" DIA. HYDRANT SHALL BE 60,000 PSI YIELD STRENGTH.  
2. HYDRANT SHALL BE 6" DIA. HYDRANT SHALL BE 60,000 PSI YIELD STRENGTH.  
3. HYDRANT SHALL BE 6" DIA. HYDRANT SHALL BE 60,000 PSI YIELD STRENGTH.  
4. HYDRANT SHALL BE 6" DIA. HYDRANT SHALL BE 60,000 PSI YIELD STRENGTH.

**NOTES:**  
1. FIRE LANE SIGNS SHALL BE POSTED ON BOTH SIDES OF FIRE APPARATUS ACCESS ROUTES EVERY 15 FEET.  
2. FIRE LANE SIGNAGE SHALL BE POSTED ON BOTH SIDES OF FIRE APPARATUS ACCESS ROUTES EVERY 15 FEET.

**PARKING FIRE LANE SIGNAGE:**  
- METAL LETTERS ON RED BACKGROUND.  
- RED LETTERING ON WHITE BACKGROUND.  
- 18" MINIMUM CLEARANCE.  
- 36" MINIMUM CLEARANCE.  
- 18" MINIMUM CLEARANCE.  
- 36" MINIMUM CLEARANCE.

TIMOTHY C. BEST, CEG  
 LICENSED PROFESSIONAL ENGINEER  
 08145 415 4842 08145 415 4841 (M)

PROJECT:  
 GUSTI FARMS - FARM LABOR HOUSING PROJECT  
 1800 HIGGINS CANYON ROAD  
 HALF MOON BAY, CA 94019  
 SAN MATEO COUNTY, CA  
 APN: 064-370-210

TITLE:  
**SITE PLAN**

REVISIONS:  
 1 05/27/2020 Revisions to include...  
 2 11/20/2020 Modified setbacks, Moved tables...

DATE: MAR 31, 2020  
 SHEET NUMBER  
**C2**

- CONCRETE
- ELECTRIC METER
- UTILITY POLE
- BOLLARD
- CONTROL POINT
- SPOT ELEVATION
- PROPERTY LINE (APPROXIMATE)
- FENCE
- DRAINAGE SWALE
- TOP OF CHANNEL BANK
- EDGE OF RIPRAP (FROM BCD, 2020)
- 50 FOOT SET BACK FROM RIPRAP AREA
- 100 FOOT SET BACK FROM RIPRAP AREA
- STREAM
- (E) BUILDING
- (E) SEPTIC
- (N) FARM LABOR HOUSING
- (N) WATER TANKS
- (N) FIRE ENGINE TURN AROUND
- (N) AGGREGATE BASE ROCK (4 INCH MIN)
- (N) SEPTIC LEACH FIELD
- ON-SITE 1 (8 BEDROOM) PRIMARY 1
- ON-SITE 1 (8 BEDROOM) PRIMARY 2
- ON-SITE 2 (8 BEDROOM) PRIMARY 1
- ON-SITE 2 (8 BEDROOM) PRIMARY 2
- EXPANSION
- (N) SPLASH BLOCK
- (N) HYDRANT
- (N) DOMESTIC WATER LINE
- (N) HYDRANT WATER LINE
- (N) ELECTRICAL
- (N) PROPANE

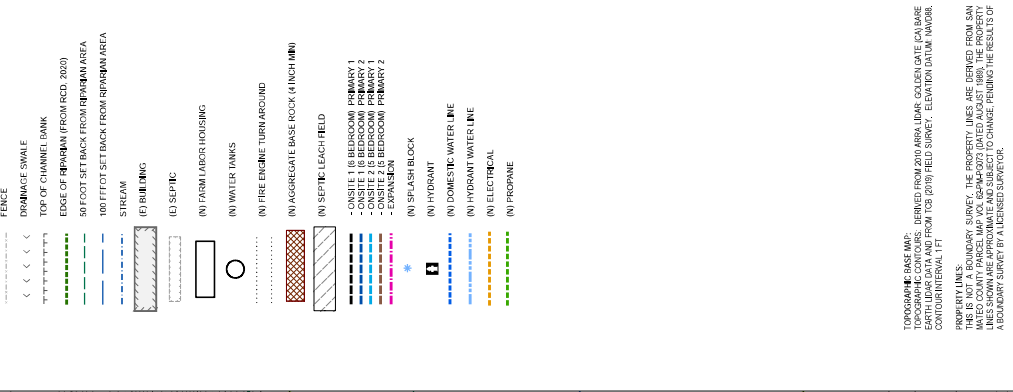

TOPOGRAPHIC BASE MAP: DERIVED FROM 2010 Aerial LiDAR. COLOR DATE CAN HAVE...  
 THIS IS NOT A BOUNDARY SURVEY. THE PROPERTY LINES ARE DERIVED FROM SAN...  
 BOUNDARY SURVEY BY A LICENSED SURVEYOR.

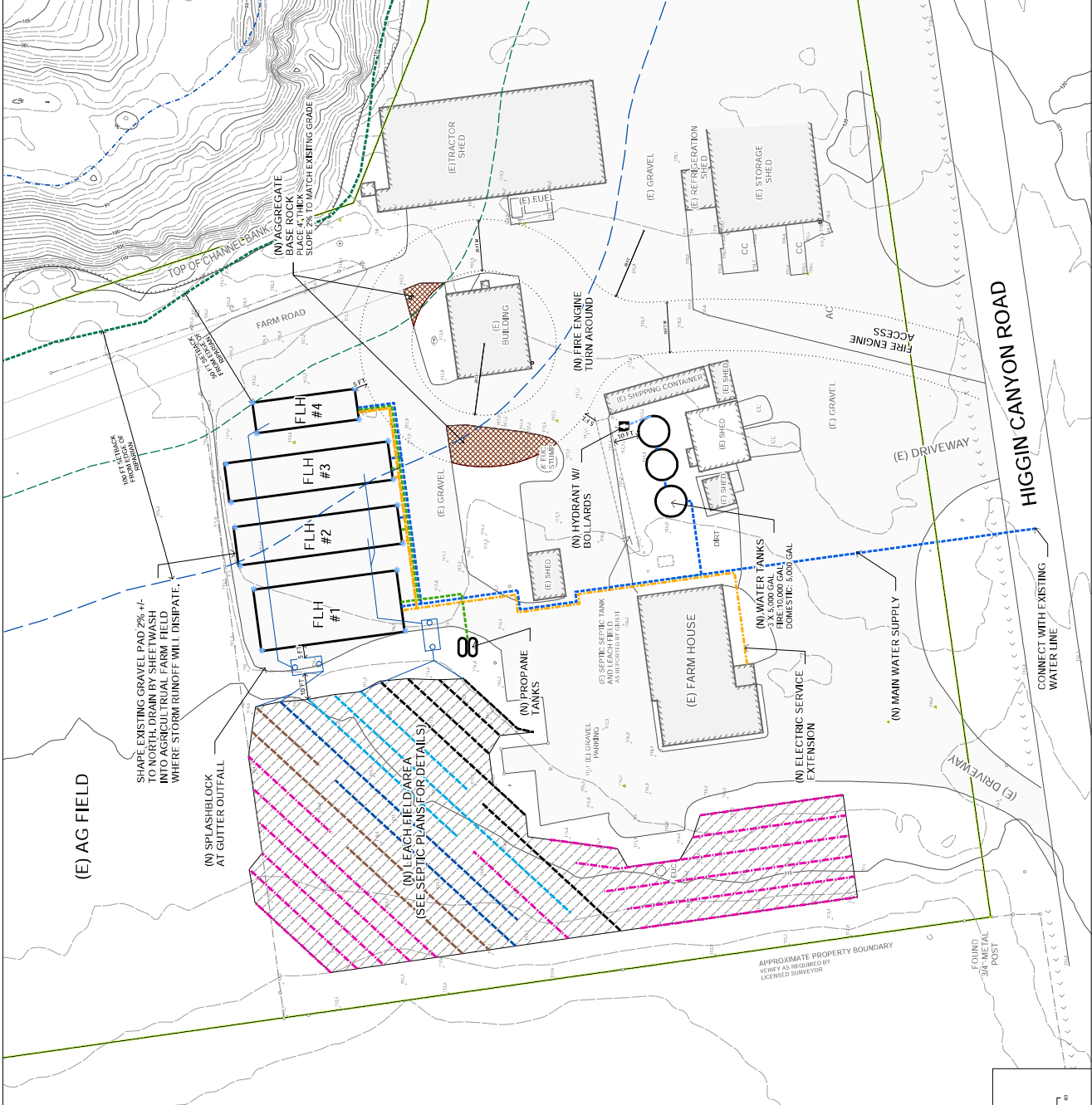

CONCRETE  
 ELECTRIC METER  
 UTILITY POLE  
 BOLLARD  
 CONTROL POINT  
 SPOT ELEVATION  
 PROPERTY LINE (APPROXIMATE)  
 FENCE  
 DRAINAGE SWALE  
 TOP OF CHANNEL BANK  
 EDGE OF RIPRAP (FROM BCD, 2020)  
 50 FOOT SET BACK FROM RIPRAP AREA  
 100 FOOT SET BACK FROM RIPRAP AREA  
 STREAM  
 (E) BUILDING  
 (E) SEPTIC  
 (N) FARM LABOR HOUSING  
 (N) WATER TANKS  
 (N) FIRE ENGINE TURN AROUND  
 (N) AGGREGATE BASE ROCK (4 INCH MIN)  
 (N) SEPTIC LEACH FIELD  
 - ON-SITE 1 (8 BEDROOM) PRIMARY 1  
 - ON-SITE 1 (8 BEDROOM) PRIMARY 2  
 - ON-SITE 2 (8 BEDROOM) PRIMARY 1  
 - ON-SITE 2 (8 BEDROOM) PRIMARY 2  
 - EXPANSION  
 (N) SPLASH BLOCK  
 (N) HYDRANT  
 (N) DOMESTIC WATER LINE  
 (N) HYDRANT WATER LINE  
 (N) ELECTRICAL  
 (N) PROPANE



TOPOGRAPHIC BASE MAP: DERIVED FROM 2010 Aerial LiDAR. COLOR DATE CAN HAVE...  
 THIS IS NOT A BOUNDARY SURVEY. THE PROPERTY LINES ARE DERIVED FROM SAN...  
 BOUNDARY SURVEY BY A LICENSED SURVEYOR.



THE: **GRADING, DRAINAGE AND EROSION CONTROL PLANS**

PROJECT: **GUSTI FARMS - FARM LABOR HOUSING PROJECT**  
 1800 HIGGINS CANYON ROAD  
 HALF MOON BAY, CA 94019  
 SAN MATEO COUNTY, CA  
 APN: 064-320-210

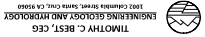

TIMOTHY C. BEST, CEG  
 LICENSED CIVIL ENGINEER, NO. 10000  
 10845 425 STREET  
 SAN MATEO, CA 94067

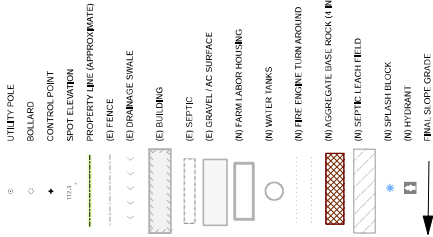

**GRADING NOTES**  
 1. PROPOSED GRADING CONFORMS TO THE PLACEMENT OF 60 SF CLASS 1A3 APPROX. 7' (7) TO STABILIZE PORTIONS OF THE PROPOSED DRIVEWAYS TO PREVENT ROAD ROCK BLADE ROCK ANCHORS AND COMPACT TO 98% RELATIVE COMPACTION.  
 2. DISSE SPREAD OF MINOR SPILLS GENERATED FROM SUBSEQUENT FOR ROAD AGRICULTURAL FARM FIELD AT THE LANDOWNER'S DISCRETION.  
 3. FINE GRADING OF EXISTING GRAVEL PAD AT THE PROPOSED FARM LABOR HOUSING TO SLOPE PAD 2% NORTHWEST TO ALLOW FOR SHEET FLOW INTO THE ADJOINING AGRICULTURAL FIELD.  
**DRAINAGE NOTES**  
 1. NO EROSION CONTROL MEASURES ARE NECESSARY AS THERE IS NO SIGNIFICANT ACCESS SITE AND INTO AGRICULTURAL FARM FIELDS WHERE RUNOFF WILL DISSE.  
**EROSION CONTROL NOTES**  
 1. NO EROSION CONTROL MEASURES ARE NECESSARY AS THERE IS NO SIGNIFICANT CONCENTRATIONS OF RUNOFF.

**TOPOGRAPHIC BASE MAP**  
 TOPOGRAPHIC CONTOURS: DERIVED FROM 2010 AERIAL IMAGE COURTESY CALI AERIAL PHOTOGRAPHY. HORIZONTAL SCALE: 1" = 100'. VERTICAL SCALE: 1" = 10'. CONTOUR INTERVAL: 1 FT.  
**PROPERTY LINES**  
 THIS IS NOT A BOUNDARY SURVEY. THE PROPERTY LINES ARE DERIVED FROM SAN MATEO COUNTY RECORD MAPS AND ARE APPROXIMATE. THE PROPERTY LINES SHOWN ARE APPROXIMATE AND SUBJECT TO CHANGE. PENDING THE RESULTS OF A BOUNDARY SURVEY BY A LICENSED SURVEYOR.  
**BUILDINGS**  
 BUILDING STRUCTURES SHOWN BY THE BEST FROM FIELD SURVEY MEASUREMENTS AND GENERAL PHOTOGRAPHIC INFORMATION.

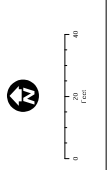
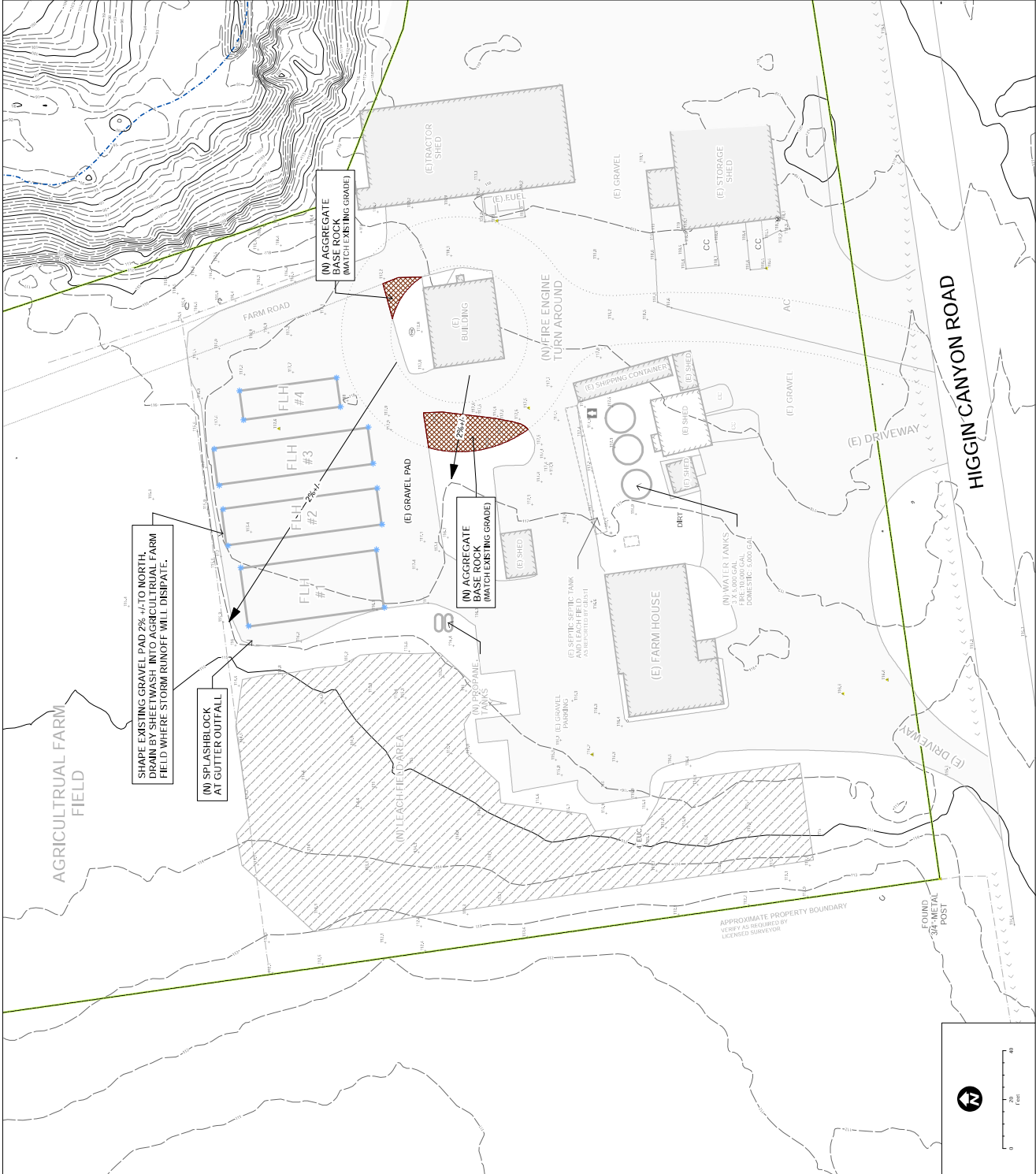



COUNTY OF SAN MATEO - PLANNING AND BUILDING DEPARTMENT

# ATTACHMENT B

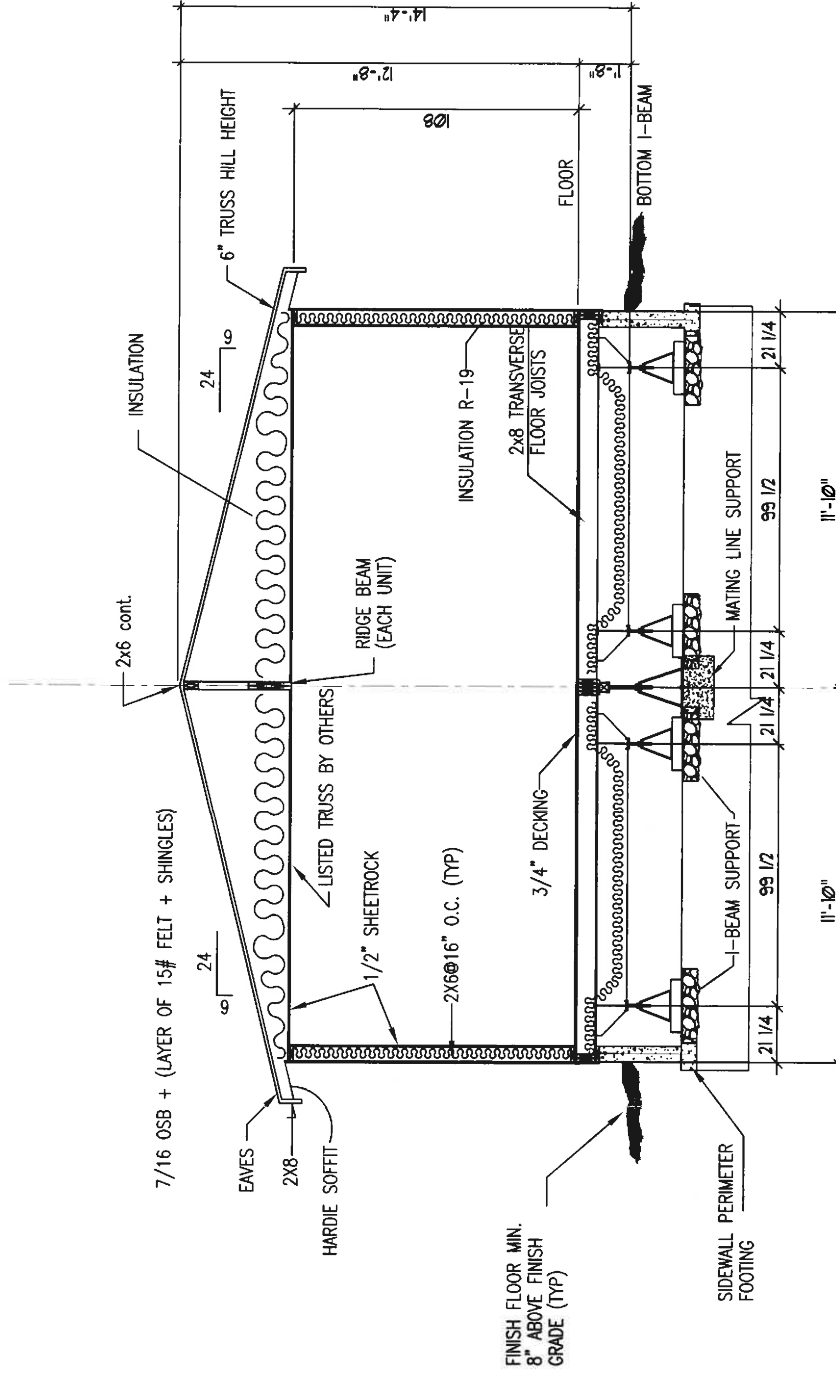

HIGH-FLAT

TYPICAL CROSS SECTION A-MODEL  
(3 ON 12 ROOF SLOPE)



(916) 919-2661 Phone

DRAWING	DBL.-WIDE SECTION / A-MODEL
DRAWN BY:	-
DATE	1-3-00
DRAWING FILE	DETAILS/2-SECTION
REVISION	07-24-08



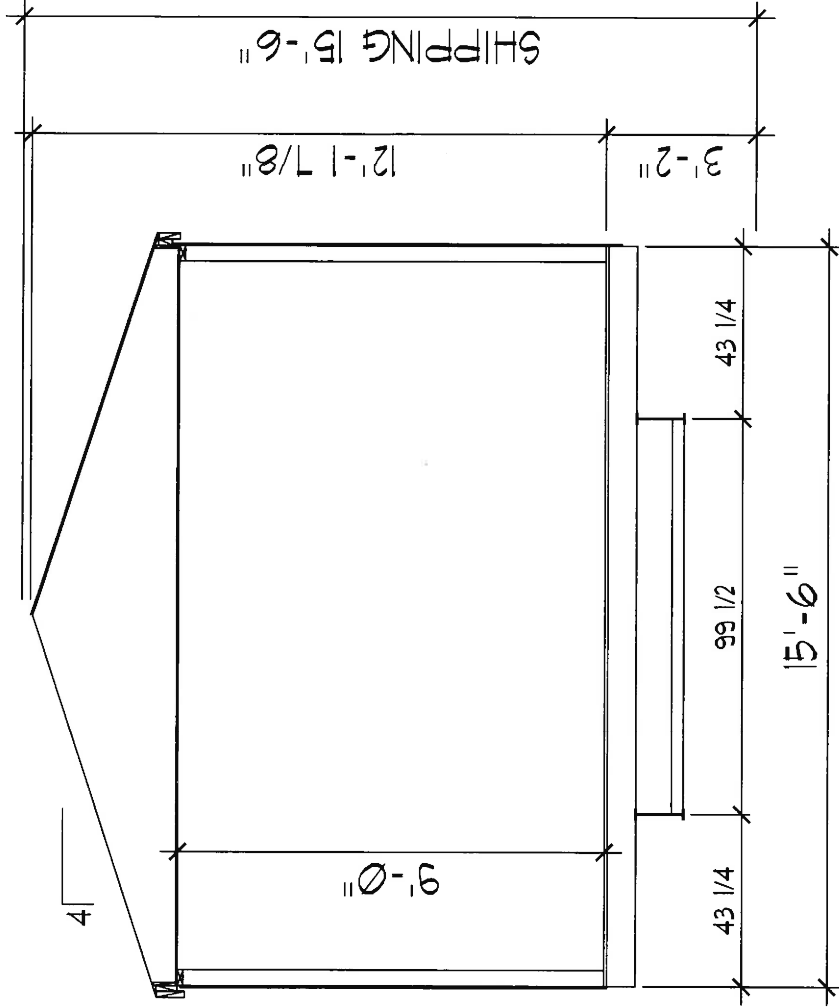

DRAWING TITLE:

**CMH**   
**MANUFACTURING INC.**  
 9998 OLD PLACERVILLE ROAD  
 SACRAMENTO, CA. 95827  
 Phone: (916) 363-2681; Fax: (916) 363-4537  
 www.claytonhomes.com www.karstenhomes.com

DRAWING FILE INFORMATION:

STANDARD AS OF ~~REVISION~~ DATE - 8'-0" WALLS-TR.F.

PRODUCT: CLAYTON SERIES

DESIGN: CL56001Q  
 SQUARE FT.:

MODEL NO.: CL56001Q

DATE: 5-01-12

REVISED: 12-23-08

SHEET: 18-A

DRAWN BY:



COUNTY OF SAN MATEO - PLANNING AND BUILDING DEPARTMENT

# ATTACHMENT C

BLACK OR DARK OLIVE GREEN

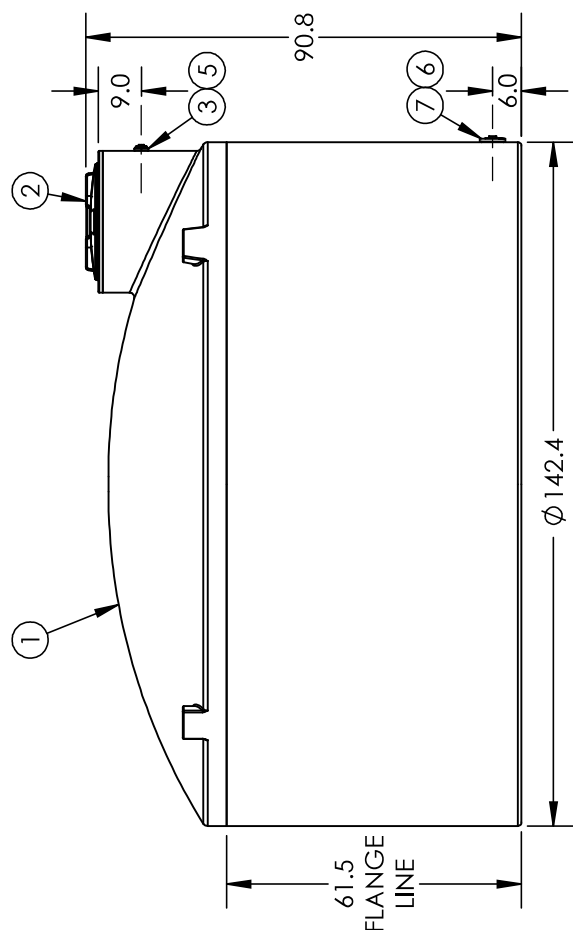
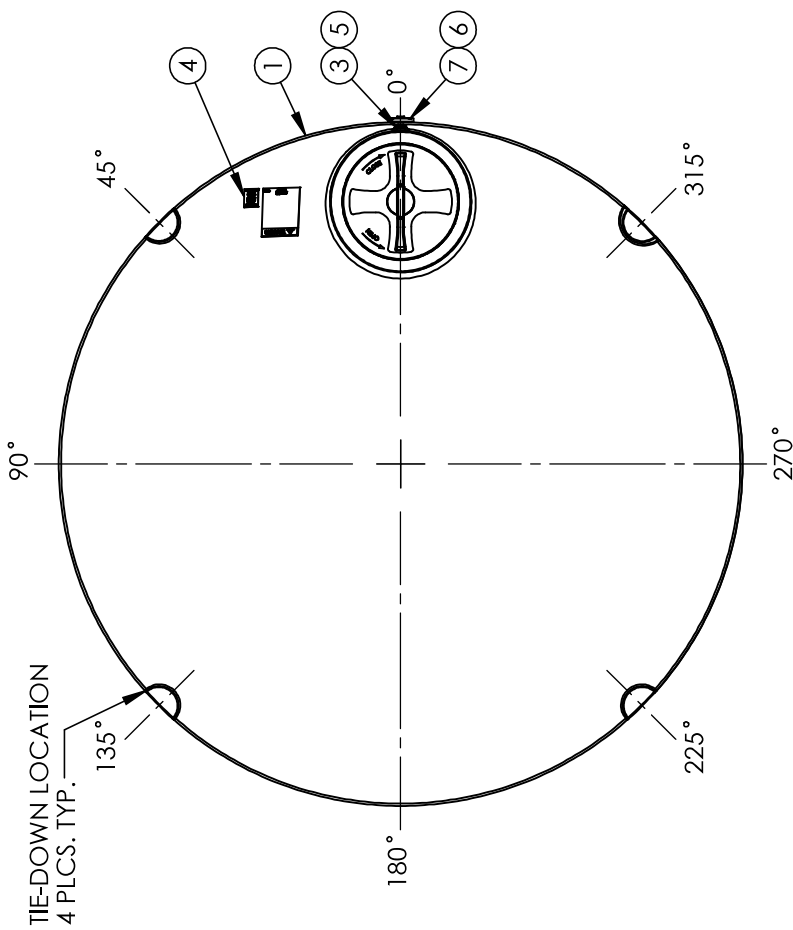

7	1	63683	FTG 2IN HD BH PP/EPDM	
6	1	60021	2' NPT PLUG	
5	1	64149	1-1/2" NPT PLUG	
4	1	99700231	DECAL NSF MARK - WATER TKS	
3	1	63931	FTG PP 1-1/2IN ECO-BH EPDM TXT	
2	1	34700352	ASM MANWAY PE 24IN VENTED	
1	1	7000200W__02	ASM TK 5000VDT X 144 NH NMW	
ITEM NO.	QTY.	C	PART NUMBER	DESCRIPTION
DO NOT SCALE		DRAWN BY		<b>Snyder</b> INDUSTRIES, INC. (402) 467-5221 www.snyderinet.com
Released		SB		
© SNYDER INDUSTRIES, INC., 2018 ALL DIMENSIONS, DESIGNS, AND SPECIFICATIONS ON THIS PRINT MUST BE CONSIDERED PROPRIETARY TO SNYDER INDUSTRIES, INC. AND MAY NOT BE USED, COPIED, OR DISTRIBUTED WITHOUT WRITTEN PERMISSION OF AN OFFICER OR THE AGENT OF THE FIRM.				TITLE: <b>ASM TK 5000VDT X 144 WATER</b> REVISION: <b>B</b> SHEET: <b>1 OF 1</b>
PART NO. <b>7000200W__03</b> ENG. ID. <b>D006342</b>				

\*ALL EXTERNAL PIPING MUST BE INDEPENDENTLY SUPPORTED.  
 \*ONLY BASE FITTINGS TO BE LEFT INSTALLED AT TIME OF SHIPMENT PER SII PROCEDURE.  
 ALL DIMENSIONS ARE IN INCHES. NOMINAL. & SUBJECT TO CHANGE WITHOUT NOTICE.  
 ALL DIMENSIONS ON ROTATIONAL MOLDED PARTS ARE SUBJECT TO A ± 3% TOLERANCE.



COUNTY OF SAN MATEO - PLANNING AND BUILDING DEPARTMENT

# ATTACHMENT D



View mobile home location and riparian



View mobile home location









**COUNTY OF SAN MATEO - PLANNING AND BUILDING DEPARTMENT**

**ITEM**

**11**

**COUNTY OF SAN MATEO  
PLANNING AND BUILDING DEPARTMENT**

**DATE:** October 19, 2020

**TO:** Agricultural Advisory Committee

**FROM:** Planning Staff

**SUBJECT:** Consideration of County-Initiated Williamson Act Contract Appeal

County File Number: PLN2017-00507 - Pawloski

**HISTORY**

In 2017, the Board of Supervisors authorized the Planning and Building Department to record a Notice of Non-renewal for certain Williamson Act contracts. These contracts were identified as non-compliant based on landowners' responses to Planning and Building Department and Assessor's Office Agricultural Questionnaires. The Notice of Non-renewal was recorded on November 7, 2017 (effective January 1, 2018); contract expiration is December 31, 2026.

Pursuant to the California Land Conservation Act of 1965, a property owner may file a written protest (appeal) of a County initiated non-renewal. The property owner identified above has filed such a protest. In filing a written protest, a landowner has up to 3 years to substantiate compliance with the Williamson Act in order to remain under contract. If evidence of compliance is submitted, the County may rescind the Notice of Non-renewal for the appealed parcels.

The 3-year appeal period will end December 31, 2020 by which time the Board of Supervisors must make a determination to rescind the Notice of Non-renewal or allow the contract to expire.

In 2013, the Board of Supervisors adopted the Williamson Act Uniform Rules and Procedures. As adopted, the Williamson Act Program (Program) identifies minimum eligibility criteria (e.g., land use designation, income requirements, etc.) for contracts, exceptions for certain criteria and limitations of compatible uses as they relate to agricultural uses on the property. Through this Program, the Agricultural Advisory Committee (AAC) is charged with reviewing contract Program compliance for recommendation to the Board of Supervisors

*Agricultural Advisory Committee Required Review and Recommendation*

A review of each appeal must be made by the AAC for minimum eligibility requirements, Determination of Compatibility, and exceptions to minimum eligibility requirements if requested by the landowner. Additionally, the AAC must recommend to the Board of Supervisors that the appealed parcel either be allowed to remain contracted or that the non-renewal remains in effect allowing the contract to expire in 2026.

Each agenda item outlines the criteria and recommendations that the AAC must address as they relate to the circumstances of each appeal.

## **DECISION MAKER**

Board of Supervisors

## **QUESTIONS FOR THE AGRICULTURAL ADVISORY COMMITTEE**

What does the Agricultural Advisory Committee recommend to the Board of Supervisors for the identified parcel in Item 1?

## **BACKGROUND**

Report Prepared By: Kelsey Lang, klang@smcgov.org

Location: 4900 Cloverdale Rd, Pescadero.

APN: 087-080-050

Environmental Evaluation: Exempt from the California Environmental Quality Act (CEQA) pursuant to Section 15061(b)(3); no potential for causing a significant effect on the environment, therefore, not subject to CEQA.

## **DISCUSSION**

### **A. KEY ISSUES**

#### **Williamson Act Program Minimum Eligibility Review**

Review of compliance with minimum eligibility requirements included reviewing a map indicating the locations of fencing and water sources for cattle, and indicating that they grazed their own cattle. The documents provided indicated that that parcel minimum requirements meet the Williamson Act Program Minimum standards but no commercial grazing operation is present since the landowners graze their own cattle. Instead, the landowners have indicated that they sell their cattle, which would qualify as the sale of an agricultural commodity under the Program. The landowners have provided income tax documents (Federal Tax Income Schedule F Form and receipts) for 2017 through 2019 years. This

information is held confidential by the Planning and Building Department unless the landowners choose to waive confidentiality at the request of staff. Staff has made no such request at this time. As such, review of minimum income requirement compliance is identified in the tables below only as “Provided” and whether the minimum income is met.

The income provided was below the minimum requirement of \$10,000 annually. As a result, the applicant is requested an exception to the minimum income requirements, on the basis that the land is highly productive and is in agricultural use.

APN 087-080-050 (152.57 acres)	Williamson Act Program Requirements	Planning Review	Compliance
Land Use Designation	Open Space or Agriculture	Agriculture	Yes
Zoning <sup>1</sup>	PAD, RM, or RM-CZ	PAD/CD	Yes
Parcel Size <sup>2</sup>	40 acres	152.57 acres	Yes
Prime Soils <sup>3</sup>	--	39.15 acres	--
Non-Prime Soils	--	113.42 acres	--
Cattle Sales Income <sup>4,5</sup>	\$10,000	Provided	No
1. Zoning designations: "PAD" (Planned Agricultural District), "RM" (Resource Management), and "RM-CZ" (Resource Management-Coastal Zone).			
2. Parcel size taken from the San Mateo County Assessor's Office records.			
3. Prime soils: Class I or Class II (U.S. Department of Agriculture Soil Conservation Service Land Use Capability Classification), Class III (lands capable of growing artichokes or Brussels sprouts, and lands qualifying for an 80-100 Storie Index Rating taken from the Planning and Building Department GIS data).			
4. Grazing land utilization is 75% of parcel acreage (Uniform Rule 2.A.7).			
5. Cattle income taken from submitted Schedule F and receipts for the 2017-2019 tax years.			

### Agricultural Uses

Commercial cattle sales are the qualifying agricultural use for this parcel, with the sale of 13 head in 2017, 17 head in 2018, and 16 head in 2019. The property owner has also stated that they have planted 14 fruit trees and are experimenting with cider production.

### Existing Development and Compatible Uses

Existing development on the parcel includes two residences, two barns, and a storage garage. The applicant also notes that the entire ranch is fenced and numerous water sources exist. In addition to granting an exception to the minimum income requirements, the Agricultural Advisory Committee must review the compatible uses and issue a Determination of Compatibility if the parcel is to remain under contract.

a. Determination of Compatibility

The landowner has submitted the requested supplemental documentation in order to calculate the compatible and agricultural uses, as follows:

*The percentage of a parcel's total area used for compatible uses on contracted lands cannot exceed the percentage used for agricultural uses and the portion of the parcel used for compatible uses cannot exceed 25 percent of the parcel size.*

Building and structures used to support the agricultural use, unpaved roads, farm labor housing, and underground utilities are excluded from this calculation.

Maximum Allowance of Compatible Uses Calculation

The following table identifies compatible uses on the parcel.

Compatible Uses	
Contract Size	152.57 acres
Agricultural Area	151.73 acres (>99% of contract area)
Compatible Uses Area	0.84 Acres (<1% of contract area)
	Main house – 2,000 square feet Lower house – 1,000 square feet Blue barn – 5,000 square feet (not included in calculation) Lower barn – 1,000 square feet (not included in calculation) Lower garage storage - 400 square feet

The contracted parcel is compliant.

b. Determination of Compatibility Issuance Criteria

In addition to the Determination of Compatibility calculation, the Agricultural Advisory Committee (AAC) must issue or not issue a Determination of Compatibility based on the following five criteria. No new development is proposed at this time, all “proposed” compatible uses are existing uses. All criteria must be met:

1. *That the primary use of the parcel would continue to be existing commercial agriculture.*
2. *That the proposed compatible use would not substantially interfere with the existing agricultural use on the subject parcel or any other property within the Agricultural Preserve.*

3. *That the proposed compatible use would not hinder or impair agricultural operations in the area by significantly increasing the permanent or temporary human population of the area.*
4. *That the proposed compatible use would not significantly displace or impair current or reasonably foreseeable agricultural operations on the parcel, or any other property within the Agricultural Preserve.*
5. *That the remaining portion of the parcel not subject to the proposed compatible use would be able to sustain the agricultural use.*

**B. STAFF EVALUATION**

Staff recommends that the exception be granted, as income from agriculture was demonstrated, the land is highly productive, and that maintaining the property in agricultural production has a significant public benefit.

**AAC CRITERIA DETERMINATION**

Determination of Compatibility

Based on the Determination of Compatibility calculation and criteria, the Agricultural Advisory Committee issues/does not issue a Determination of Compatibility for APN 087-080-050.

**RECOMMENDATION**

Regarding the Non-renewal Appeal, does the AAC recommend to the Board of Supervisors that the Notice of Non-renewal be rescinded for the appealed parcels or that the contract be allowed to expire for the appealed parcels?

**ATTACHMENT**

- A. Vicinity Map



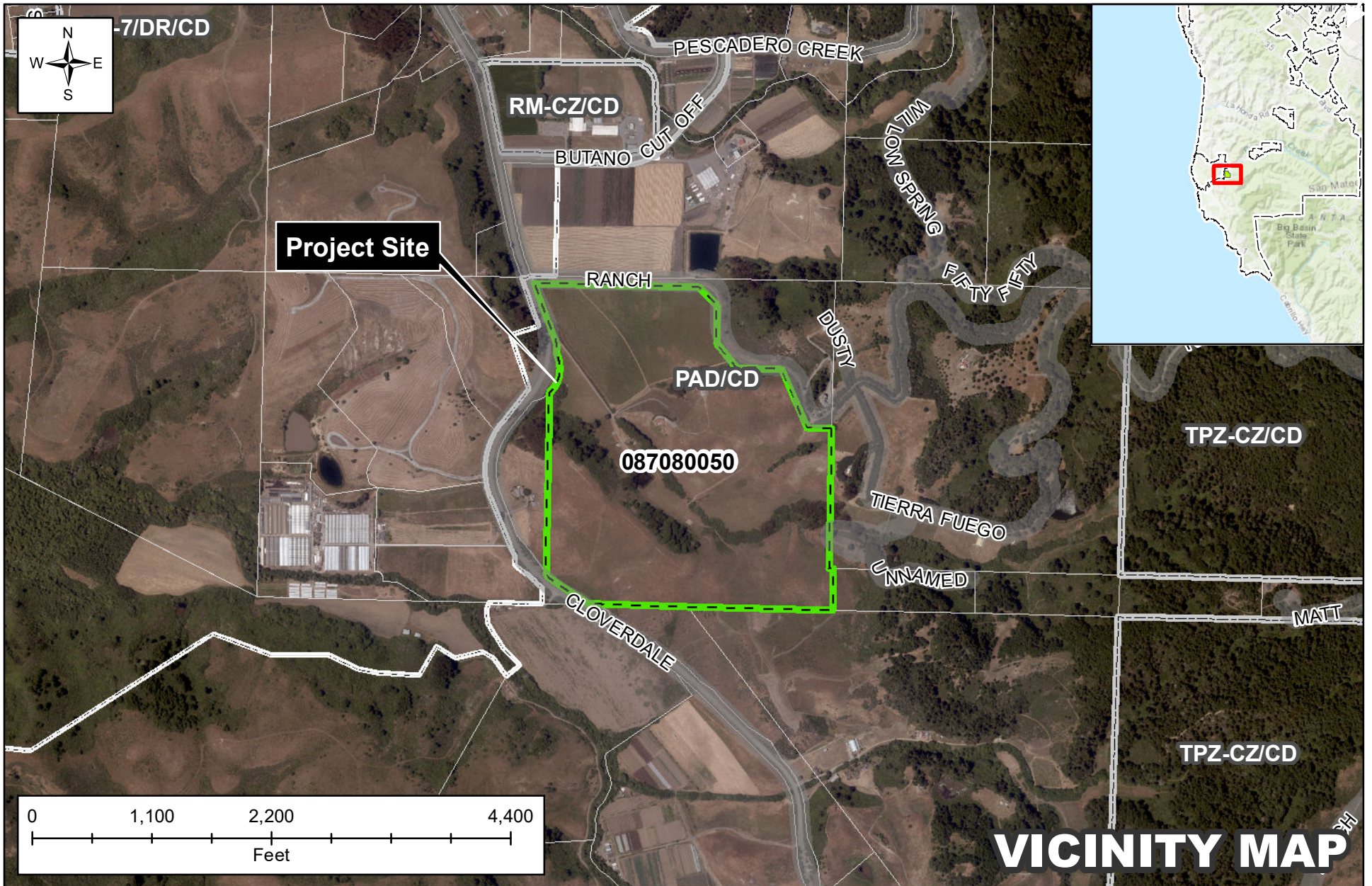



**COUNTY OF SAN MATEO - PLANNING AND BUILDING DEPARTMENT**

**ITEM**

**13**

# MEMORANDUM

## COUNTY OF SAN MATEO PLANNING AND BUILDING DEPARTMENT

**DATE:** October 19, 2020

**TO:** Agricultural Advisory Committee

**FROM:** Laura Richstone, Planning Department Liaison

**SUBJECT:** Agritourism Educational Events Clarification

During its August 2020 meeting, the AAC requested Planning Staff to clarify Agritourism Guidelines and events permitted with a focus on educational events. Staff has provided a table that outlines uses permitted with the issuance of a Temporary Agritourism Event Permit. Please note that the Agritourism Guidelines are not exhaustive of all possibilities that may be permitted on a property. These guidelines provide discretion for the Community Development Director to permit/not-permit certain activities due to their intensity and/or impact(s). This memorandum should be utilized as a guideline only and does not replace nor supersede the Agritourism Guidelines. Prior to engaging in an Agritourism Event-like use, please engage with the Planning Department to inquire if that use will be permitted and discuss what permits may be necessary.

Temporary agritourism events are limited to 45 or less consecutive days, or 2 or less times per year. All other longer-term events may require a Planned Agricultural District Permit, Resource Management Permit, and/or a Coastal Development Permit to be approved/denied by the County.

COMMON TEMPORARY AGRITOURISM EVENTS	
Soil Types	Uses Permitted
All Soil Types (Prime & Non-Prime)	One pony ride area (Confined Animal Permit or Exemption required)
	One farm animal petting zoo
	One hayride
	One train ride with rubberized wheels
	One food vendor, mobile or on site (Environmental Health permits required)
	Two inflatables (Subject to height regulations)
	Other recreational/educational activities subject to review and approval of the Community Development Director.
	Commercial Dining/Dinner Events (Cannot overlap with another temporary agritourism event)
	Other recreational/educational activities subject to review and approval of the Community Development Director.



	One food vendor (mobile or on-site)
Non-Prime Soils	One prepackaged food/snack bar (May be subject to Environmental Health permit)

Regarding educational events, these events are permitted via a Temporary Agritourism Event Permit on a case by case basis and are subject to the review of the AAC and Community Development Director to assess potential impacts and to determine if the use/event is secondary to, and compatible with, the agricultural uses of the land

The following questions are typically asked to assess potential impacts and compatibility when reviewing a Temporary Agricultural Event Permit for educational activities:

1. What is the scope?
2. What is the event for?
3. Is the event secondary and compatible with the current agriculture on site?
4. What is the duration?
  - a. Hours/Days?
  - b. Frequency?
5. What is the intensity of the use?
  - a. How many people?
6. Parking?
  - a. Where?
  - b. How many spaces provided vs. how many needed?
  - c. On prime or non-prime soils?
  - d. Adequate access?
  - e. Impacts on adjacent roadways?
7. Will the event have the potential to impact adjacent property owners?
  - a. Noise?
  - b. Light?
  - c. Access?
  - d. Ability to farm on adjacent property impacted?
8. Are there current violations on the property?
9. Will the event require grading or the construction of new/additional infrastructure?
10. Will the event impact sensitive habitat areas or species?
11. Is the property under a Williamson Act Contract?
  - a. Will the event/use comply with the Contract if a property is under Contract?
12. Will additional permits be required by other agencies?

While not exhaustive, the above list provides guidance to determine potential impacts of a proposed agritourism event. If the event is temporary and is not expected to result in significant impacts, the Community Development Director may determine that the proposed use is eligible for a Temporary Agricultural Event Permit. However, the Community Development Director also has the discretion to require full permits for the proposed activity (i.e. Planned Agricultural District, Resource Management, and/or Coastal Development Permit) if he deems they are necessary.

\* A copy of the Agritourism Guidelines can be found in your binder, at the Planning Department offices, and online at <https://planning.smcgov.org/documents/agritourism-guidelines>



**COUNTY OF SAN MATEO - PLANNING AND BUILDING DEPARTMENT**

**ITEM**

**15**



**COUNTY OF SAN MATEO  
PLANNING AND BUILDING DEPARTMENT**

**DATE:** October 19, 2020

**TO:** Agricultural Advisory Committee  
**FROM:** Planning Staff  
**SUBJECT:** Community Development Director's Report

**CONTACT INFORMATION:** Laura Richstone, Planner II, [lrichstone@smcgov.org](mailto:lrichstone@smcgov.org)

The following is a list of Planned Agricultural District permits and Coastal Development Exemptions for the rural area of the County that have been received by the Planning Department from July 28, 2020 to October 1, 2020.

**PLANNED AGRICULTURAL DISTRICT PERMIT OUTCOMES**

The following PAD permit was heard or considered by the Planning Commission during this time period.

1. 

<i>Owner:</i>	<i>TomKat Ranch LLC</i>
<i>Applicant:</i>	<i>Kerry Burke</i>
<i>County File Number:</i>	<i>PLN 2019-00379</i>
<i>Location:</i>	<i>2997 Pescadero Road, Pescadero</i>
<i>APN:</i>	<i>087-110-020</i>

*Consideration of an After-the-Fact Coastal Development Permit and Planned Agricultural District Permit to legalize a greenhouse and the conversion of a barn to office space.*

*This item was heard and recommended for approval at the May 2020 AAC meeting. The project was approved by the Planning Commission on August 12, 2020.*

**UPCOMING PLANNED AGRICULTURAL DISTRICT PERMIT PROJECTS**

No PAD permit applications were submitted during this time period.

**COASTAL DEVELOPMENT EXEMPTIONS FOR AGRICULTURAL PROJECTS**

Three rural CDX applications were submitted during this time period. Please see the attached status report regarding the CDX application. The CDX list includes the description of the project and its status. Copies of the CDX are available for public review upon request.

**ADDITIONAL ANNOUNCEMENTS**

1. The following projects are located in the PAD but do not require PAD permits. As noted these projects were either submitted or approved during this time period

- a. The following CPD was submitted on March 19, 2020 and considered by the Planning Commission:

*Owner: County of San Mateo  
 Applicant: Department of Public Works and County Parks  
 County File Number: PLN 2020-00119  
 Location: Unincorporated Coastal Zone  
 APN: Various*

*Consideration of a CDP to authorize routine maintenance activities at County parks over the course of 5 years as part of the Department of Public Works Master Permit for the County’s Routine Maintenance Program. Activities include culvert, bridge, ditch, swale, and other storm drainage maintenance, sediment removal, bank stabilization, vegetation management, and trail and road maintenance.*

*This CDP was approved by the Planning Commission on September 9, 2020*

- b. The following General Plan Conformity (GPC) was submitted on July 29, 2020 and considered by the Planning Commission:

*Owner: Marsh Rober E & Julia M TRS  
 Applicant: Midpeninsula Regional Open Space District  
 County File Number: PLN 2020-00236  
 Location: 1000 Verde Road, Half Moon Bay  
 APN: 066-280-050; 066-280-010; 066-010-020*

*Consideration of a GPC of MROSD’s proposal to purchase a 54% interest in the 600-acre South Cowell Ranch with eventual plans for and a subsequent land division resulting in a 371-acre Uplands property to be owned in fee by the District*

*The GPC was approved by the Planning Commission on September 23, 2020.*

- c. One rural CDP permit application was submitted on August 10, 2020.

*Applicant: Kerry Burke  
 County File Number: PLN 2020-00263  
 Location: Cabrillo HWY & Purisima Creek Road  
 APN: 066-180-040*

*Consideration of a CDP to remove an abandoned oil well facility. The project is appealable to the Coastal Commission.*

- d. The following Commercial Cannabis Permits were submitted on September 30, 2020:

File Number	Location	Entity Name
MNA 2020-00020	4525 Cloverdale Road	Serenity Flowers
MNA 2020-00021	4525 Cloverdale Road	GH Science
MNA 2020-00022	4525 Cloverdale Road	MVG Science
MNA 2020-00023	4525 Cloverdale Road	Whispy Flowers

2. The next regular meeting of the AAC is scheduled for November 9, 2020.
3. AAC meetings will be held via videoconference until further notice to adhere to social distancing guidelines.

Rural CDX list

# COUNTY OF SAN MATEO

Count Distinct(RECORD ID)						
3						
Permit Number	RECORD NAME	DATE OPENED	DESCRIPTION	APN	ADDR FULL LINE1	RECORD STATUS
<a href="#">PLN2020-00247</a>	EVENT	8/3/2020	CDX for a one-time, 150-car, evening drive-in movie event with food trucks and pre-packaged on August 13, 2020, at the Johnston House (property owned by the City of Half Moon Bay and POST) in the County unincorporated area (APNs 065-210-110 and 065-210-090, respectively). Applicant is working directly with City of Half Moon Bay and Environmental Health Services. No temporary event permit needed per Lisa A. This Johnston House is listed on the Federal Register of Historic Places.	065210110	HIGGINS PURISSIMA RD, HALF MOON BAY, CA null	Approved
<a href="#">PLN2020-00276</a>	REPAIR	8/18/2020	CDX to replace 6 termite damaged eave support posts and adjoining framing, like-for-like replacement, on commercial building.	086042250	PESCADERO RD, PESCADERO, CA null	Submitted
<a href="#">PLN2020-00321</a>	CONFINED ANIMAL	9/24/2020	Confined Animal Permit Exemption and CDX for the construction of a 400 sq. ft. weather shelter and 300 sq. ft. hay barn to support 5 donkeys. Zoning: PAD/CD	036143050	ALTA VISTA RD, MONTARA, CA null	Submitted